

7. Evacuating and Charging

The following points should be kept in mind when evacuating and charging with a manifold gauge set.

- 1) Be certain that goggles and gloves are worn.
- 2) If bulk refrigerant [13.6 kg (30 lb) canister] is used, be certain to weigh the charge amount carefully, using the correct equipment, to avoid overcharging the system.
- 3) The charging procedure described in this section begins by charging **liquid** refrigerant into the high-pressure side of the system **with the engine off**. The procedure is completed by charging refrigerant **vapor** into the low-pressure side of the system with the engine running.

CAUTION:

Never open the high-pressure manifold valve when the engine is running.

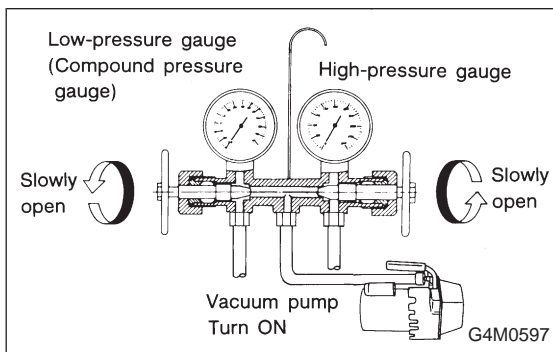

1. CONNECT THE GAUGE SET

- 1) Close the high- and low-pressure manifold valves.
- 2) Attach the low-pressure manifold hose to the low-pressure service port on the vehicle. Check the low-pressure gauge. If more than 68.6 kPa (0.70 kg/cm², 10 psi) is indicated, discharge the system prior to charging.
- 3) Attach the high-pressure manifold hose to the high-pressure service port on the vehicle.
- 4) Connect the center hose from the manifold to the vacuum pump.
- 5) Turn on the vacuum pump.
- 6) Slowly open the low-pressure manifold valve.
- 7) When the low-pressure gauge reaches approximately 66.43 kPa (498.3 mmHg, 19.62 inHg), slowly open the high-pressure manifold valve.

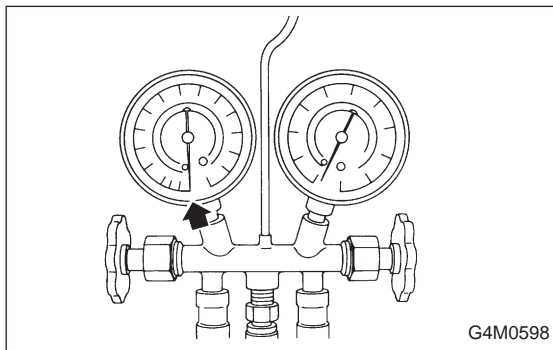

- 8) Maintain a minimum vacuum level of 100.56 kPa (754.4 mmHg, 29.70 inHg) for a minimum of 15 minutes on a new system or 30 minutes for an in-service system.

NOTE:

The gauge will read 4 kPa (25 mmHg, 1 inHg) less for every 304.8 m (1,000 ft) above sea level.

7. Evacuating and Charging

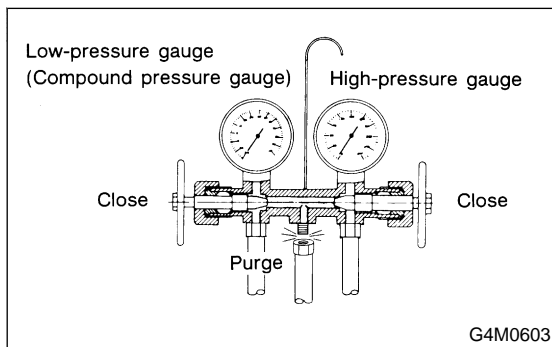
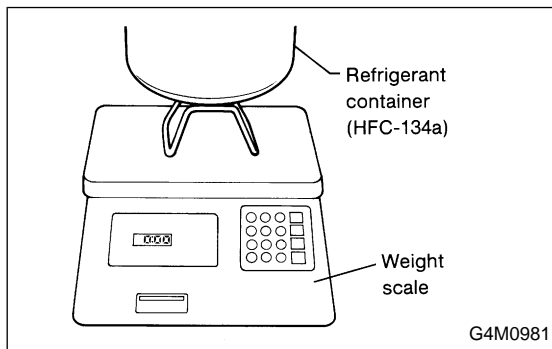
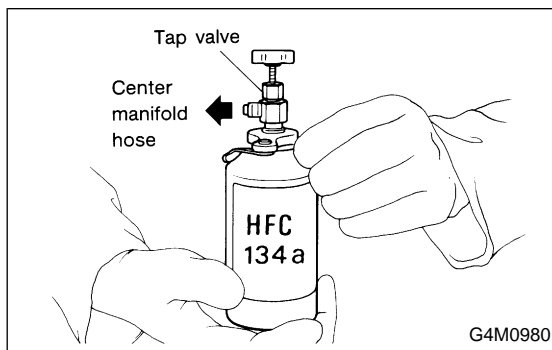
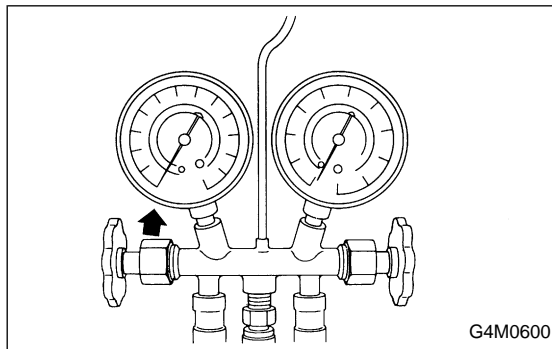
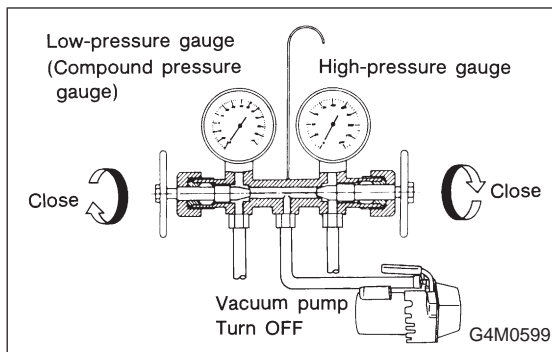
**2. PERFORM A VACUUM LEAK TEST**

- 1) After 15 minutes (or more) of evacuation, close the high-pressure manifold valve.
- 2) Close the low-pressure manifold valve.
- 3) Turn off the vacuum pump.

- 4) Note the low side gauge reading.
- 5) After 5 minutes, re-check the low-pressure gauge reading. If the vacuum level has changed more than 4 kPa (25 mmHg, 1 inHg), perform an HFC-134a leak test. If the vacuum reading is about the same as noted in step 2-4), continue on to step 2-6).

- 6) Carefully attach the can tap to the refrigerant can by following the can tap manufacturer's instructions.
- 7) Disconnect the center manifold hose from the vacuum pump and connect the hose to the tap valve.

- 8) If a 13.6 kg (30 lb) container of refrigerant is used a weight scale will be needed. This scale is to determine the amount of refrigerant that is used. Connect the center hose from the manifold to the valve. Place the 13.6 kg (30 lb) container on the scale, valve end down.

3. PURGE THE CENTER HOSE

- 1) Verify that all three hose connections are tight at the manifold gauge set.
- 2) Open the valve on the HFC-134a source.
- 3) **With safety equipment in place (goggles and gloves), use extreme caution** and loosen the center hose connection at the manifold and allow the HFC-134a to escape for no more than two or three seconds, then quickly retighten the hose fitting at the manifold.

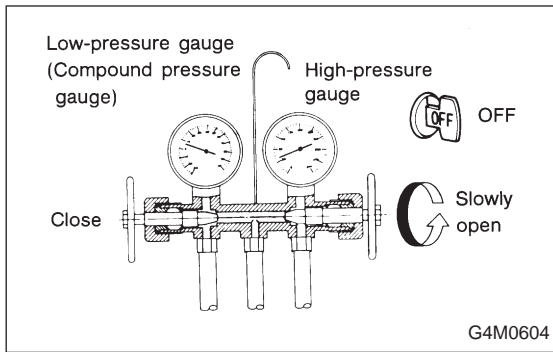

4. INITIAL CHARGING THROUGH THE HIGH SIDE

- 1) Connect a tachometer to the engine.
- 2) **With the engine off**, start charging by slowly opening the high-pressure manifold valve.

NOTE:

The initial charge rate can be increased by immersing the can in lukewarm [Below 38°C (100°F)] water for a short time.

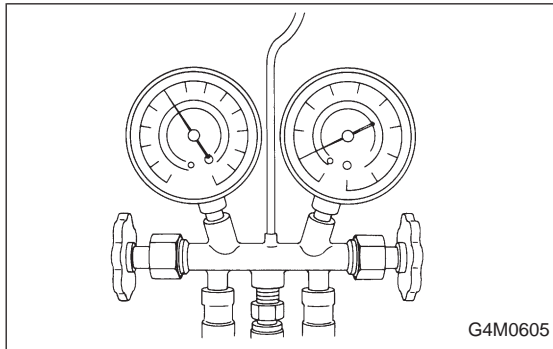

5. CHECK THE GAUGE READINGS

When both the high- and low-pressure gauge readings are about equal, or the HFC-134a source is empty, or the system has been filled to specifications, close the high-pressure manifold valve.

6. ADD ADDITIONAL CANS

If the HFC-134a source is exhausted, first close the high-pressure manifold valve, second, close the can tap valve, then slowly purge the refrigerant from the service hose by loosening the fitting at the can tap. Repeat steps 15 through 19 as necessary.

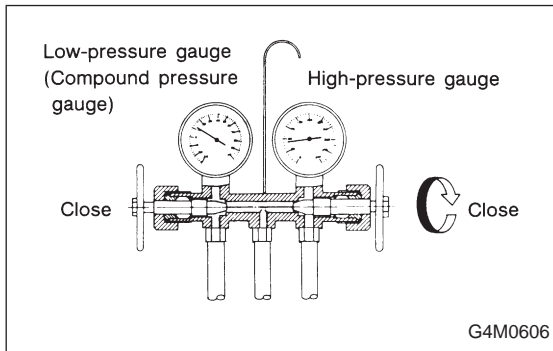

7. COMPLETE CHARGING THROUGH THE LOW SIDE

- 1) Verify that the high-pressure manifold valve is closed (should have already been closed).
- 2) Verify that the low-pressure manifold valve is closed (should have already been closed).

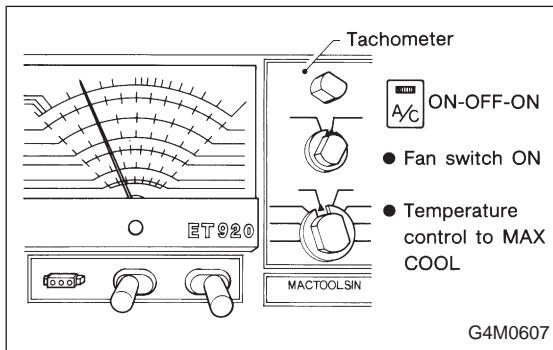

- 3) With the A/C switch off and the windows rolled down, start the engine and run at idle rpm.
- 4) Set the A/C controls on maximum cool and set the blower speed on the highest setting.
- 5) Quickly turn the A/C switch on-off-on-off a few times to prevent initial compressor damage due to "load shock." Finish this operation with the A/C switch in the ON position.
- 6) Raise engine rpm to approximately 1,500 rpm.

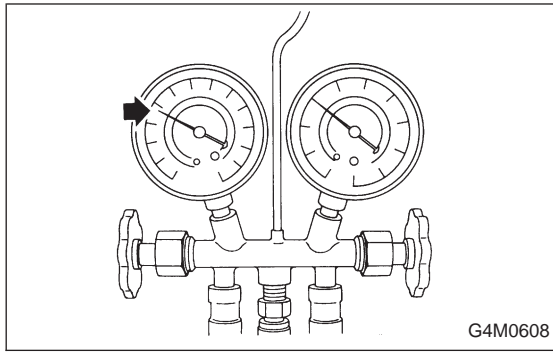

8. CHARGE THE SYSTEM

1) With the refrigerant source connected and the service hose purged, slowly open the low-pressure manifold valve, while checking the low-pressure gauge reading.

CAUTION:

The refrigerant source must be positioned for vapor (valve up).

2) Keep the low side pressure below 276 kPa (2.81 kg/cm², 40 psi) by using the low-pressure manifold valve to regulate the flow of refrigerant into the system.

3) When the system is fully charged, close the low-pressure manifold valve.

4) Close the valve at the refrigerant source.

● Refrigerant capacity

Unit: kg (lb)

Refrigerant	Minimum	Maximum
HFC-134a	0.6 (1.3)	0.7 (1.5)

9. COMPLETE ALL SYSTEM CHECKS

1) Evaluate the system performance (refer to performance testing section).

2) Perform leak detection test.

CAUTION:

Always perform leak checking in an environment free of refrigerant pollution.

Do not disconnect the high- or low-pressure hoses from the vehicle before leak checking.

10. DISCONNECT THE MANIFOLD GAUGE SET

Remove the high- or low-pressure hoses from the service ports and install the service port caps.