

8. Diagnostic Chart with Select Monitor

A: BASIC DIAGNOSTIC CHART

If no trouble codes appear in the on-board diagnostic operation (although problems have occurred or are occurring), measure performance characteristics of sensors, actuators, etc., in the "F" mode (select monitor function), and compare with the "basic data" to determine the cause of problems.

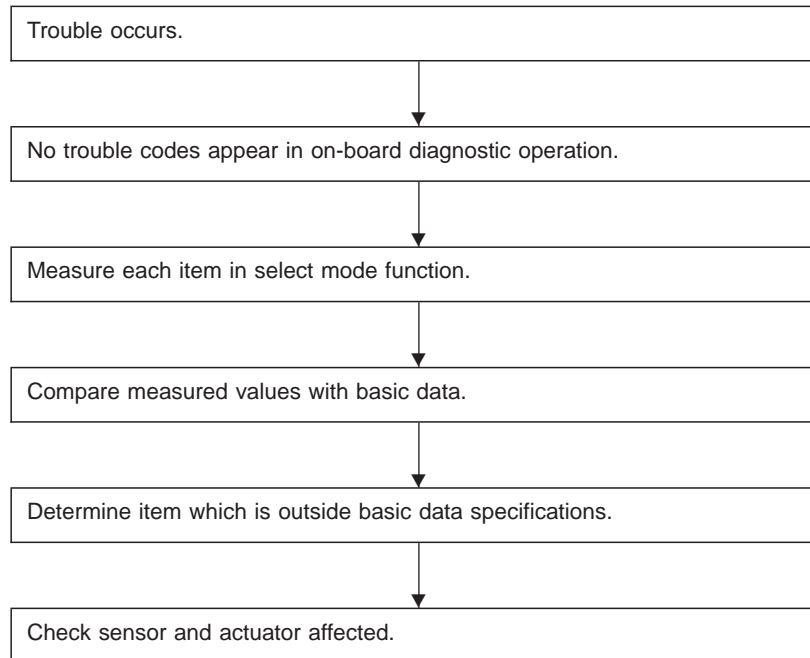

B: LIST OF OUTPUT MODES**1. FUNCTION MODE**

Mode	Contents	Abbr.	Unit	Contents of display	Page
F00	Mode display	—	—	AT or EGI mode (when monitor is connected.)	56
F01	Battery voltage	VB	V	Battery voltage applied to control unit.	56
F02	Vehicle speed sensor 1	VSP1	m/h	Vehicle speed (miles/h) sent from vehicle speed sensor 1.	57
F03	Vehicle speed sensor 1	VSP1	km/h	Vehicle speed (km/h) sent from vehicle speed sensor 1.	57
F04	Vehicle speed sensor 2	VSP2	m/h	Vehicle speed (miles/h) sent from vehicle speed sensor 2.	57
F05	Vehicle speed sensor 2	VSP2	km/h	Vehicle speed (km/h) sent from vehicle speed sensor 2.	57
F06	Engine speed	EREV	rpm	Engine speed sent from ECM.	58
F07	ATF temperature sensor	ATFT	°F	ATF temperature (°F) sent from ATF temperature sensor.	58
F08	ATF temperature sensor	ATFT	°C	ATF temperature (°C) sent from ATF temperature sensor.	58
F09	Throttle position sensor	THV	V	Voltage sent from throttle position sensor.	59
F10	Gear position	GEAR	—	Transmission gear position	59
F11	Line pressure duty	PLDTY	%	Duty ratio flowing through duty solenoid A.	60
F12	Lock-up duty	LUPTY	%	Duty ratio flowing through duty solenoid B.	61
F13	AWD duty	4WDTY	%	Duty ratio flowing through duty solenoid C.	62
F14	Throttle position sensor power supply	THVCC	V	Power supply voltage to throttle position sensor	63
F15	Mass air flow signal	AFM	V	Output voltage from air flow sensor	63

2. ON ↔ OFF SIGNAL LIST

Mode	LED No.	Signal name	Display	LED "ON" requirements	Page
FA0	1	FWD switch	FF	When fuse is installed in FWD switch.	—
	2	Kick-down switch	KD		—
	3	—	—		—
	4	—	—		—
	5	Brake switch	BR	When brake switch is turned ON.	—
	6	ABS switch	AB	When ABS signal is entered.	—
	7	Cruise control set	CR	When cruise control is set.	—
	8	Power switch	PW		—
	9	—	—		—
	10	—	—		—
FA1	1	P/N range switch	NP	When P or N range is selected.	—
	2	R range switch	RR	When R range is selected.	—
	3	D range switch	RD	When D range is selected.	—
	4	3 range switch	R3	When 3 range is selected.	—
	5	2 range switch	R2	When 2 range is selected.	—
	6	1 range switch	R1	When 1 range is selected.	—
	7	Diagnosis switch	SS	When diagnosis switch is turned ON.	65
	8	—	—		—
	9	—	—		—
	10	—	—		—

NOTE; LED Nos. 2 and 8 cannot be turned on.

3. DIAGNOSIS MODE

Mode	Contents	Abbr.	Contents of display
FB0	On-board diagnostics	DIAG.U	Current trouble code determined by on-board diagnostics.
FB1	On-board diagnostics	DIAG.M	Previous trouble code stored in memory by on-board diagnostics.
FC0	Back-up clear	—	Function of clearing trouble code stored in memory.

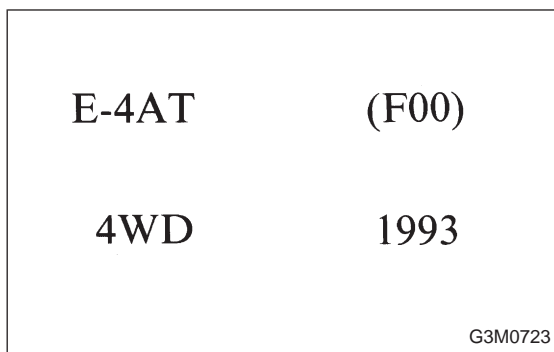

C: MODE F00 — MODE DISPLAY —

SPECIFIED DATA:

Data at the left should be indicated.

Probable cause (if outside "specified data")

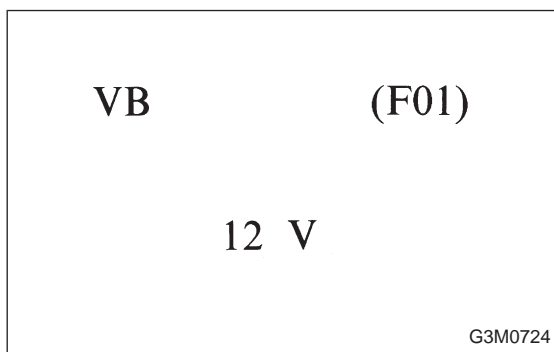
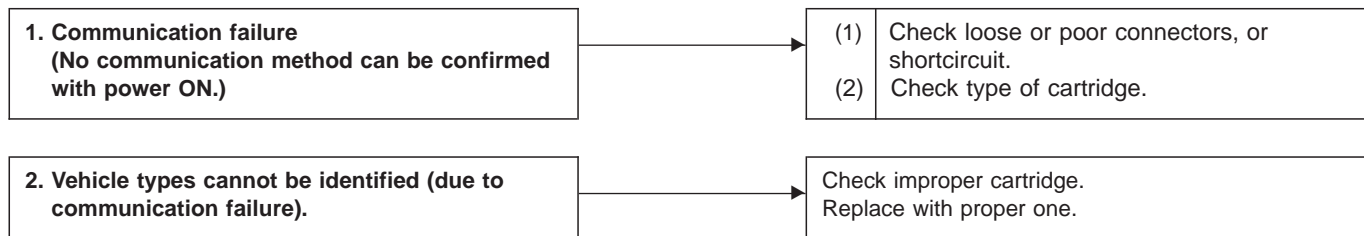

D: MODE F01 — BATTERY VOLTAGE (VB) —

CONDITION:

- Ignition switch ON
- Engine idling after warm-up

SPECIFIED DATA:

VB: 10 — 16 V

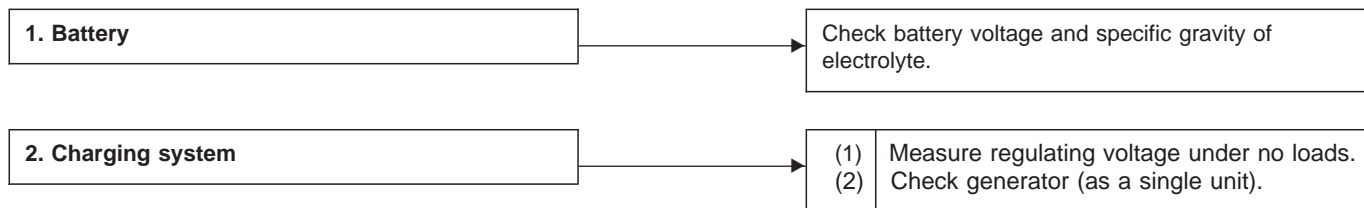

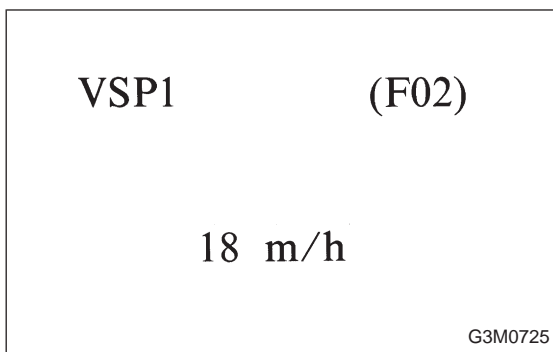

E: MODE F02

— VEHICLE SPEED SENSOR 1 (VSP1) —

F03 = vehicle speed (VSP1):
to be indicated in “km/h”.

CONDITION:

Raise vehicle off ground and operate at constant speed.

SPECIFIED DATA:

Compare speedometer with monitor indications.

Probable cause (if outside “specified data”)

1. Vehicle speed sensor 1

Check performance characteristics of vehicle speed sensor 1. <Ref. to 3-2 [T7L0].>

OK

Check TCM and replace if necessary.

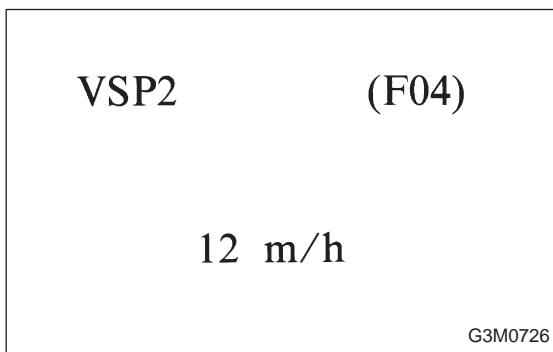

F: MODE F04

— VEHICLE SPEED SENSOR 2 (VSP2) —

F05 = vehicle speed (VSP2):
to be indicated in “km/h”.

CONDITION:

Raise vehicle off ground and operate at constant speed.

SPECIFIED DATA:

Compare speedometer with monitor indications.

Probable cause (if outside “specified data”)

1. Vehicle speed sensor 2

Check performance characteristics of vehicle speed sensor 2. <Ref. to 3-2 [T7M0].>

OK

Check TCM and replace if necessary.

EREV (F06)

1,500 rpm

G3M0727

G: MODE F06 — ENGINE SPEED (EREV) —

CONDITION:

Measure with engine operating at constant speed.

SPECIFIED DATA:

Same as tachometer reading (in combination meter)

Probable cause (if outside "specified data")



ATFT (F07)

176 deg F

OBD0386

H: MODE F07

— ATF TEMPERATURE SENSOR (ATFT) —

F08 = ATF temperature (ATFT): to be indicated in "deg C".

CONDITION:

- Low ATF temperature (before engine/vehicle starts.)
- High ATF temperature (after driving vehicle for warm-up.)

SPECIFIED DATA:

- Ambient temperature: ±50°F (±10°C)
(Low ATF temperature)
- ATF temperature: 158 — 230°F (70 — 110°C)
(High ATF temperature)
- Open harness: 176 deg F (80 deg C)
- Shorted harness: 320 deg F (160 deg C)

Probable cause (if outside "specified data")

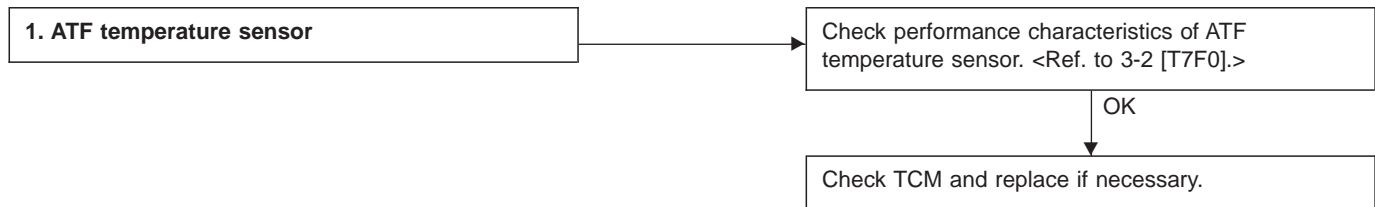

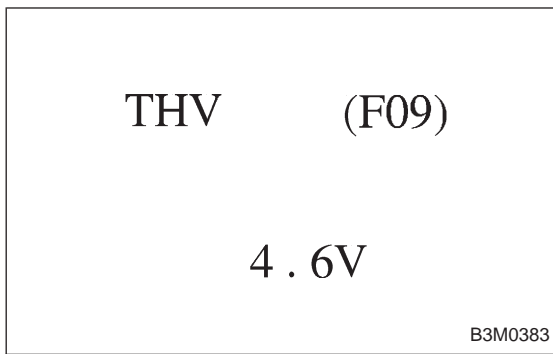

I: MODE F09 — THROTTLE POSITION SENSOR (THV) —

CONDITION:

- Ignition switch ON (with engine OFF)
- Measure voltage while operating throttle valve from a fully closed position to a fully open position.

SPECIFIED DATA:

- Fully closed position: 0.5±0.2 V
- Fully open position: 4.6±0.3 V
- From fully closed to fully open position: Voltage must smoothly decrease.
- Open harness: 5.0±0.3 V
- Shorted harness: 0.00 V

Probable cause (if outside “specified data”)

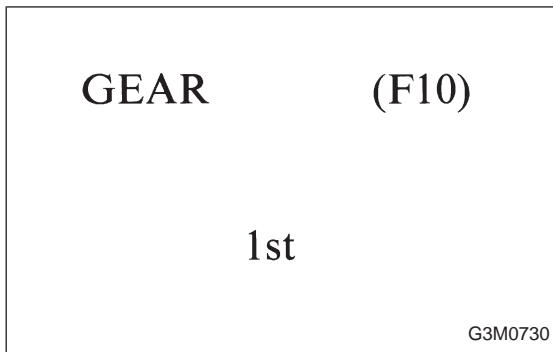
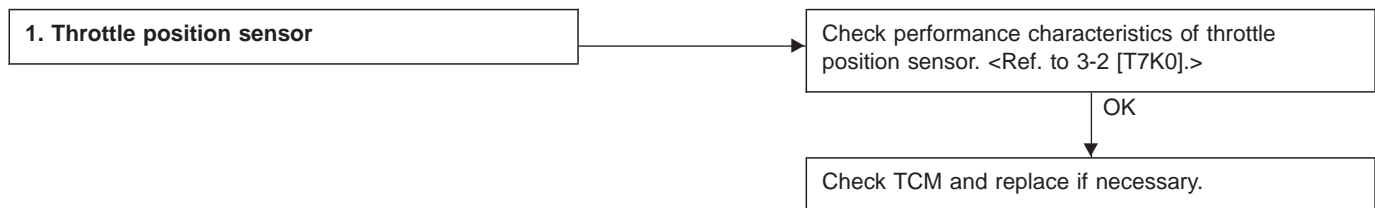

J: MODE F10 — GEAR POSITION (GEAR) —

CONDITION:

Check while driving vehicle (after warm-up).

SPECIFIED DATA:

Gear position (Refer to shift performance characteristics chart.)

Probable cause (item outside “specified data”)

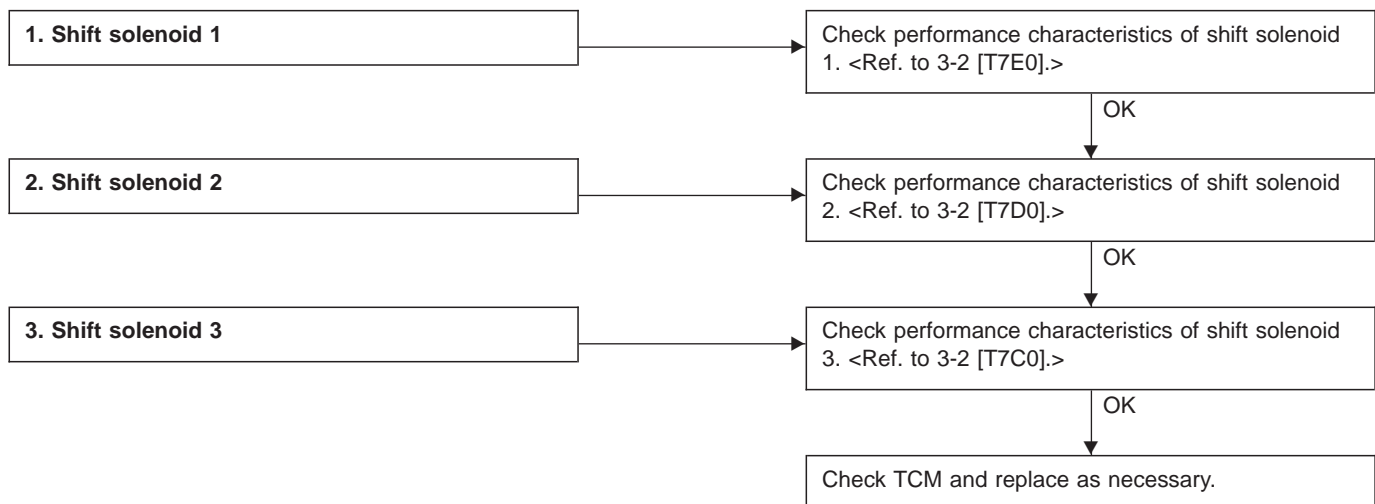

PLDTY (F11)

50%

G3M0731

K: MODE F11
— LINE PRESSURE DUTY (PLDTY) —

CONDITION:

- After sufficient warm-up
- Ignition ON (engine OFF)
- N range

SPECIFIED DATA:

- Throttle fully closed: 100%
- Throttle fully open : 15% or less

Probable cause (if outside "specified data")

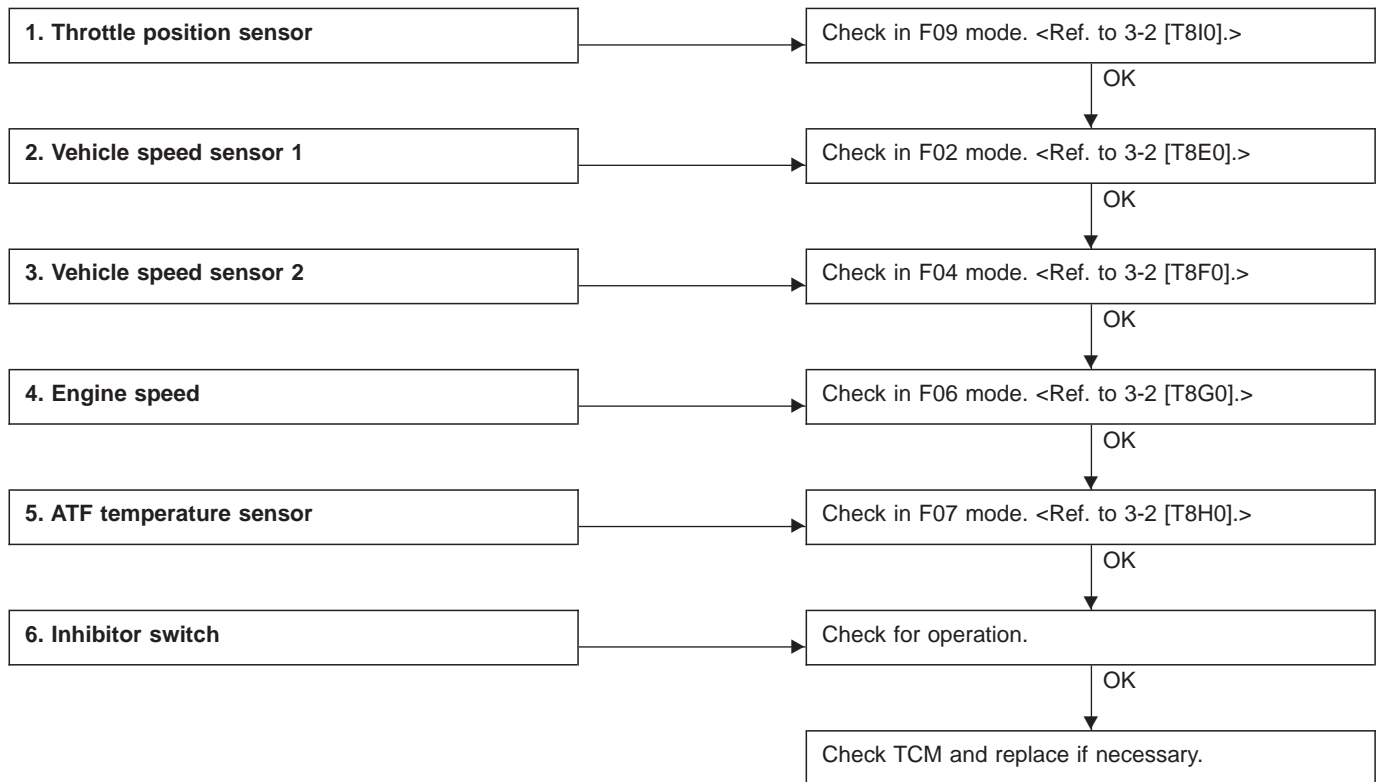

LUDTY (F12)

5%

G3M0732

L: MODE F12 — LOCK-UP DUTY (LUDTY) — CONDITION:

- Idling (after sufficient warm-up) with lock-up system released.
- Driving at 75 km/h (47 MPH) (after sufficient warm-up) with lock-up system applied.

SPECIFIED DATA:

- Lock-up system released: 5%
- Lock-up system applied: 95%

Probable cause (if outside "specified data")

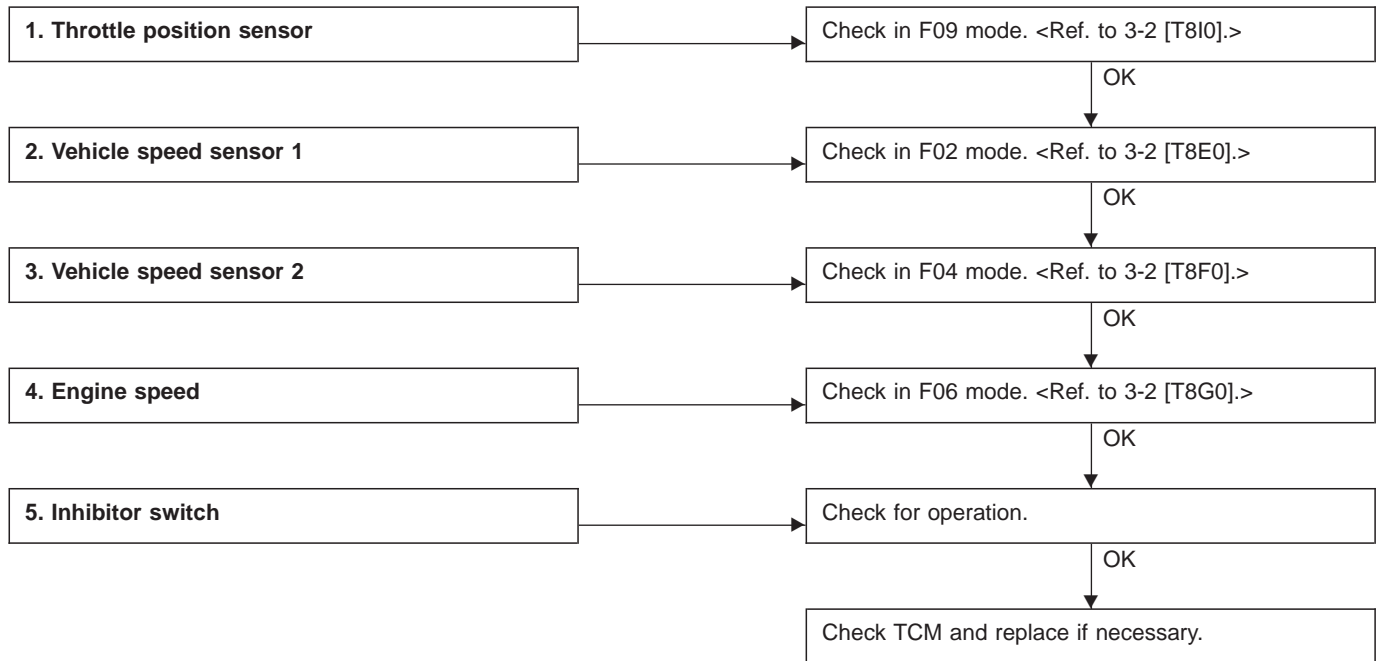

4WDTY (F13)

95%

G3M0733

M: MODE F13 — AWD DUTY (4WDTY) —

CONDITION:

- After sufficient warm-up
- Ignition switch ON (engine OFF)
- FWD mode
- AWD mode, D range, full throttle

SPECIFIED DATA:

- 95% (FWD mode)
- 25%, max. (vehicle speed 0 m/h) (AWD mode)

Probable cause (if outside "specified data")

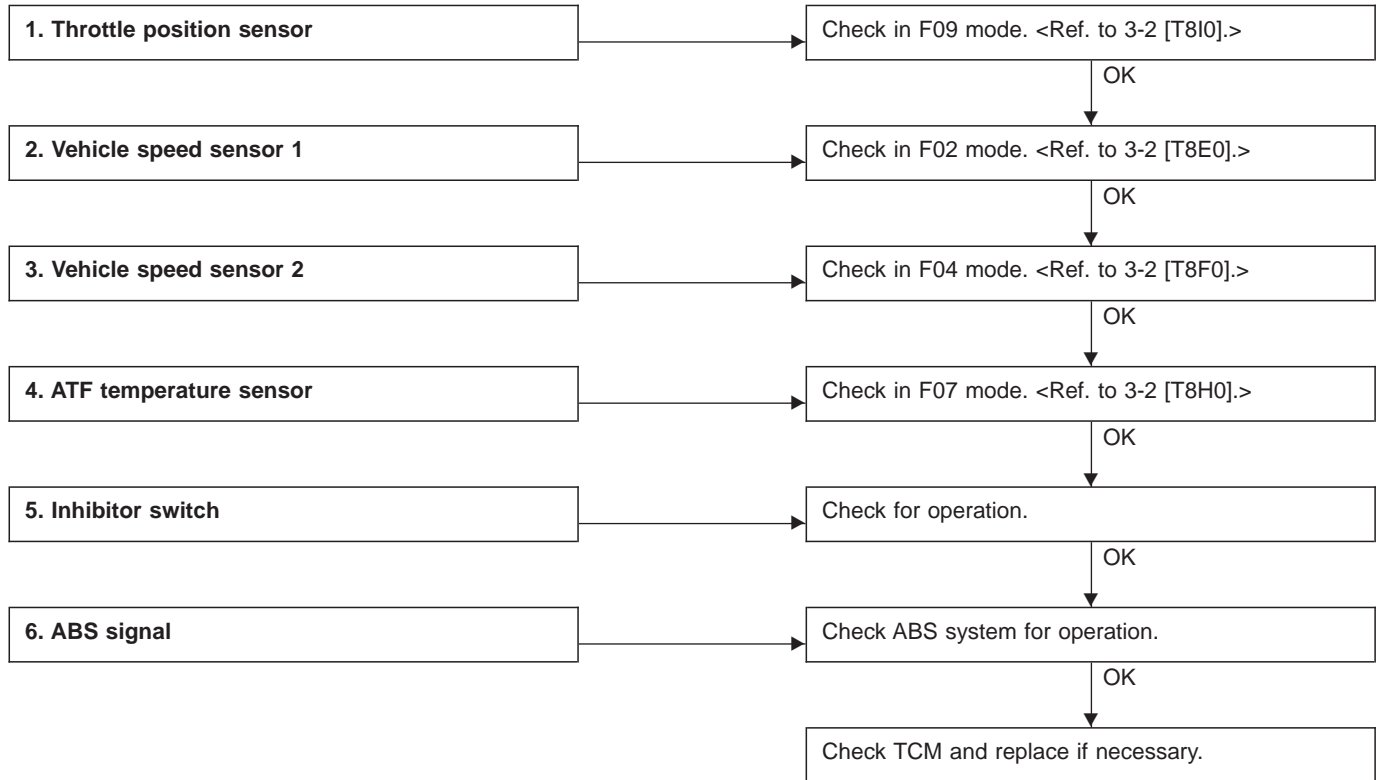

THVCC (F14)

5.2 V

B3M0259

N: MODE F14
— THROTTLE POSITION SENSOR POWER SUPPLY (THVCC) —

CONDITION:

Ignition switch ON (engine OFF)

SPECIFIED DATA:

5.12±0.1 V

Probable cause (Item outside "specified data")



AFM (F15)

0.6V

B3M0370

O: MODE F15
— MASS AIR FLOW SIGNAL (AFM) —

CONDITION:

- Ignition switch ON (engine ON)
- N range
- Idling

SPECIFIED DATA:

Engine warm-up: 0.5 — 1.22 V

Probable cause (if outside "specified data")

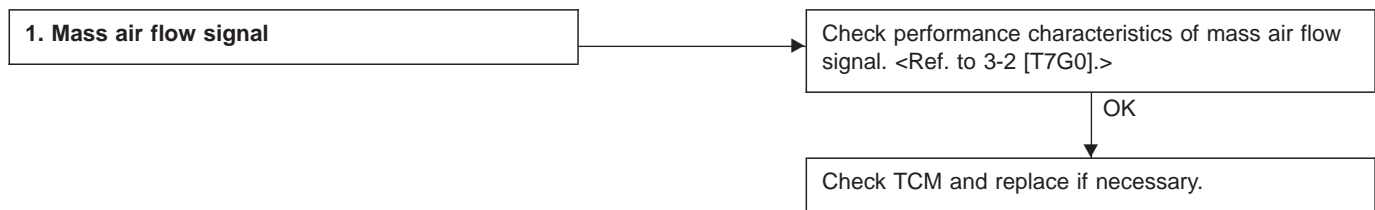

DISPLAY

LED No.	Signal name	Symbol
1	FWD switch	FF
2	Kick-down switch	KD
3	—	—
4	—	—
5	Brake	BR
6	ABS switch	AB
7	Cruise control set	CR
8	Power switch	PW
9	—	—
10	—	—

FF	KD	—	—	BR
AB	CR	PW	—	—

1	2	3	4	5
6	7	8	9	10

P: MODE FA0**— SWITCH 1 (SW1) —****Reference values**

- Lights up when the fuse is installed in FWD switch (No. 1).
- Light up when the brake pedal is depressed (No. 5).
- Light up when the ABS signal is entered (No. 6).
- Lights up when the cruise control is set (No. 7).

NOTE:

LED Nos. 2 and 8 do not come on.

DISPLAY

LED No.	Signal name	Symbol
1	N/P range switch	NP
2	R range switch	RR
3	D range switch	RD
4	3 range switch	R3
5	2 range switch	R2
6	1 range switch	R1
7	Diagnosis switch	SS
8	—	—
9	—	—
10	—	—

NP	RR	RD	R3	R2
R1	SS	—	—	—

1	2	3	4	5
6	7	8	9	10

Q: MODE FA1**— SWITCH 2 (SW2) —****Reference values**

- Lights up when the N or P range is selected (No. 1).
- Lights up when the R range is selected (No. 2).
- Lights up when the D range is selected (No. 3).
- Lights up when the 3 range is selected (No. 4).
- Lights up when the 2 range is selected (No. 5).
- Lights up when the 1 range is selected (No. 6).
- Lights up when the diagnosis switch is connected (No. 7).

NOTE:

If each LED does not illuminate in the above conditions, inhibitor switch malfunction may occur. Perform diagnostics on inhibitor switch. <Ref. to 2-7 [T10AT0].>

**R: MODE FA1
— LED No. 7, DIAGNOSIS SWITCH —**

DIAGNOSIS:

- LED does not come on when diagnosis switch is ON.
- Diagnosis switch circuit is open or shorted.

Probable cause (if outside "specified data")

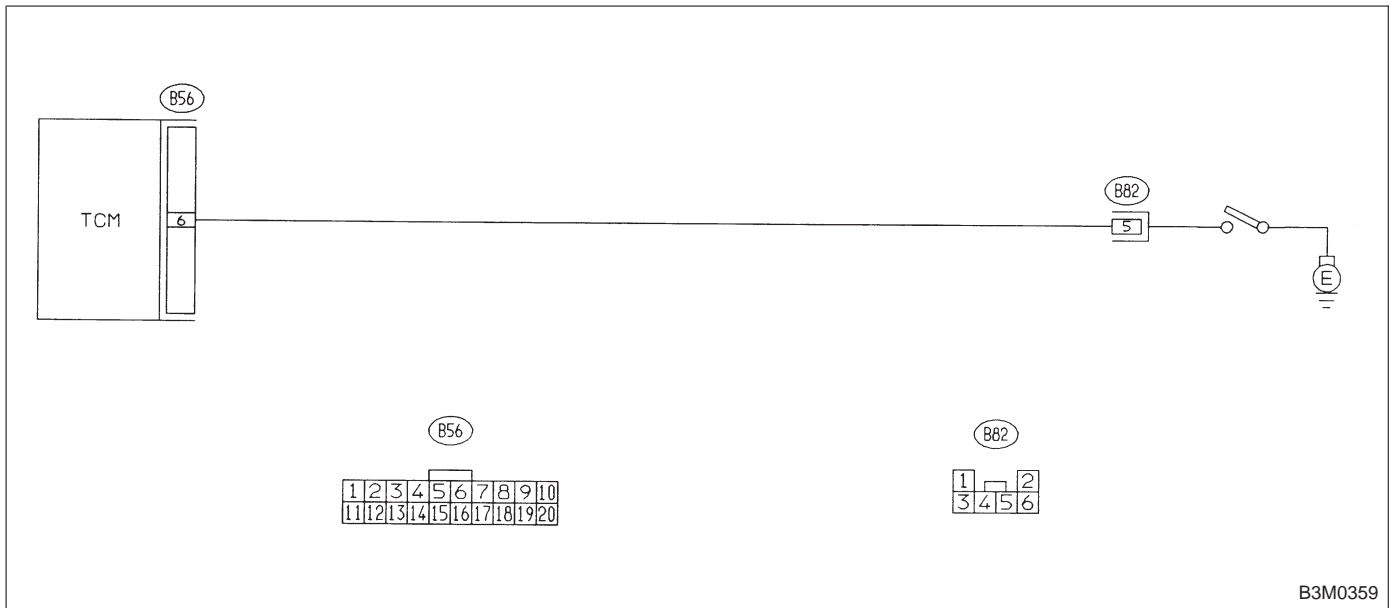
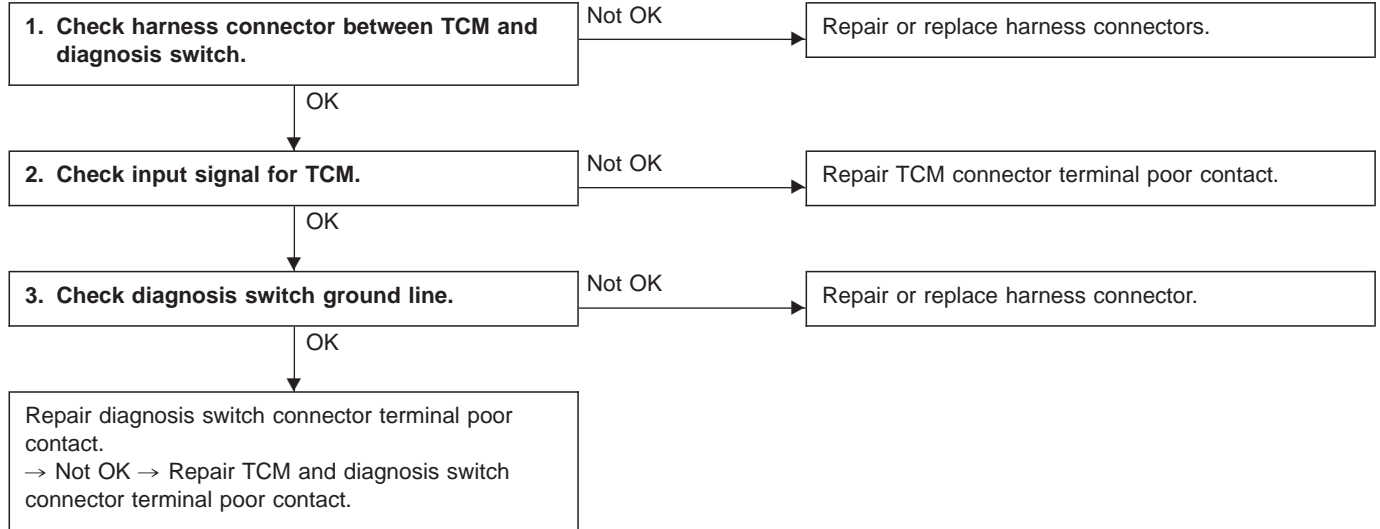

B3M0359

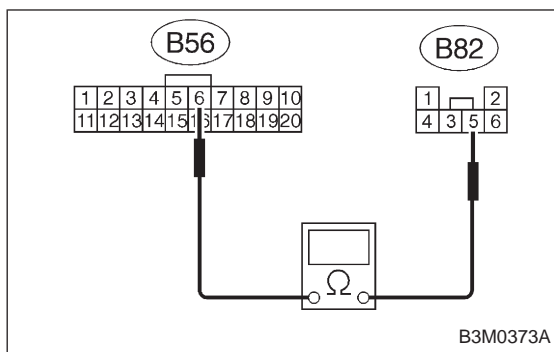

1. CHECK HARNESS CONNECTOR BETWEEN TCM AND DIAGNOSIS SWITCH.

- 1) Turn ignition switch OFF.
- 2) Disconnect connector from TCM.
- 3) Measure resistance of harness connector between TCM and diagnosis switch.

Connector & terminal / Specified resistance:
(B56) No. 6 — (B82) No. 5 / 1 Ω , or less.

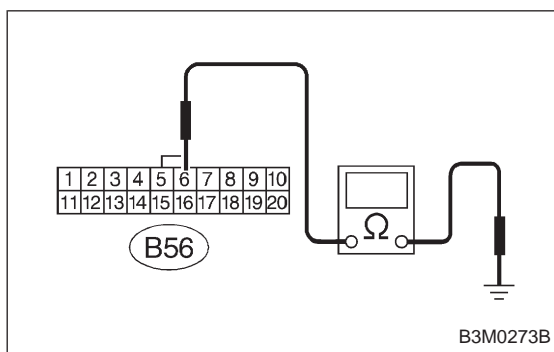

- 4) Measure resistance of harness connector between TCM and body to make sure that circuit does not short.

Connector & terminal / Specified resistance:
(B56) No.6 — Body / 1 M Ω , or more

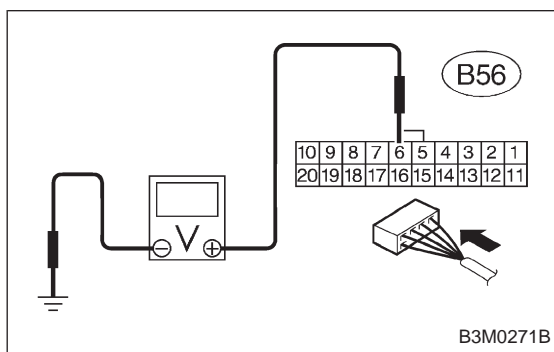

2. CHECK INPUT SIGNAL FOR TCM.

- 1) Connect connector to TCM.
- 2) Turn ignition switch ON (with engine OFF).
- 3) Measure signal voltage for TCM while connecting and disconnecting the diagnosis terminal to diagnosis connector.

Connector & terminal / Specified voltage:
(B56) No. 6 — Body / Less than 1 V (Connected)
More than 6 V (Disconnected)

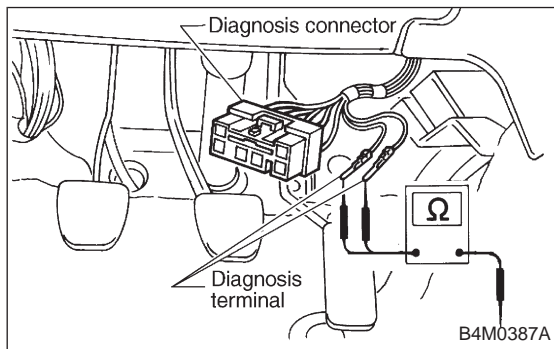

3. CHECK DIAGNOSIS SWITCH GROUND LINE.

Measure resistance of harness terminal between diagnosis terminal and body.

Connector & terminal / Specified resistance:
(B81) — Body / 1 Ω , or less