

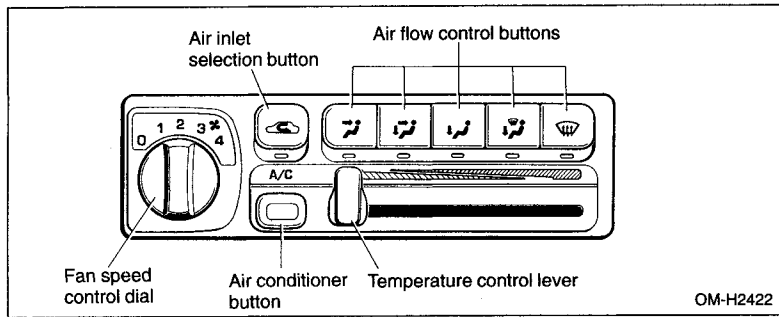





Heating and air conditioning



■ Air flow control buttons

These buttons allow you to select the air flow outlets.



-  : Air flows through the instrument panel outlets.
-  : Air flows through the instrument panel outlets and the foot outlets.
-  : Air flows through the foot outlets and some through the windshield defroster outlets.
-  : Air flows through the windshield defroster outlets and foot outlets.
-  : Air flows through the windshield defroster outlets.

— CONTINUED —

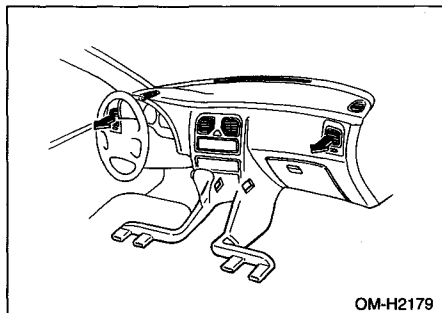
NOTE



Air flows through the outer instrument panel outlets regardless of the air flow control button position.

- When the "  " or "  " button is selected, air inlet selection is automatically set to the "OFF" position. (Outside air drawn into the passenger compartment.)
- If your vehicle is equipped with an air conditioner, when the "  " button is selected, air inlet selection is automatically set to the "OFF" position and the air conditioner automatically operates regardless of the position of the air conditioner switch.

■ Temperature control lever

This lever regulates the temperature of air flow from the air outlets over a range from the blue area to red area.

■ Fan speed control dial

The fan operates only when the ignition switch is turned to the "ON" position. The fan speed control dial is used to select four fan speeds.

■ Air inlet selection button

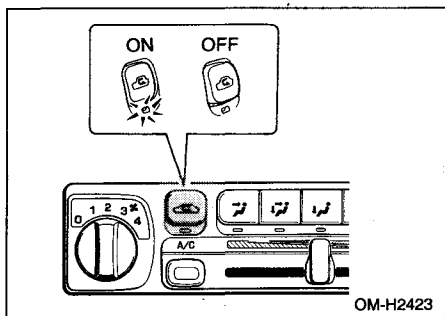

WARNING

Continued operation in the ON position may fog up the windows. Switch to the OFF position as soon as the outside dusty condition clears.



ON position: Interior air is recirculated inside the vehicle. Push the air inlet selection button to the ON position. The indicator light will come on.

OFF position: Outside air is drawn into the passenger compartment. Push the air inlet selection button again to the OFF position. The indicator light will go off.

When the "  " or "  " button is selected, air inlet selection is automatically set to the "OFF" position. (Outside air drawn into the passenger compartment.)

■ **Air conditioner button (if equipped)**

The air conditioner operates only when the engine is running.

Push the air conditioner button while the fan is in operation to turn on the air conditioner. The indicator light will come on.

Push it again to turn off the air conditioner.

- CONTINUED -

HEATER OPERATION

■ Defrosting or defogging the windshield

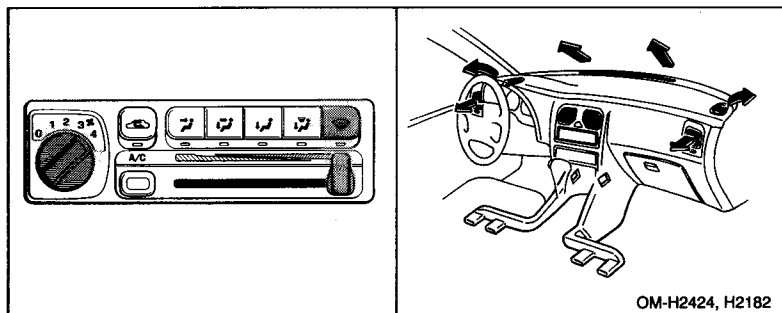

To direct warm air to the windshield and front door windows:

1. Push the "  " button in.
2. Set the temperature control lever all the way to the right in the red area.
3. Set the fan speed control dial to the highest speed.

▼ Adjustable side defroster grille (for driver's side – if equipped)

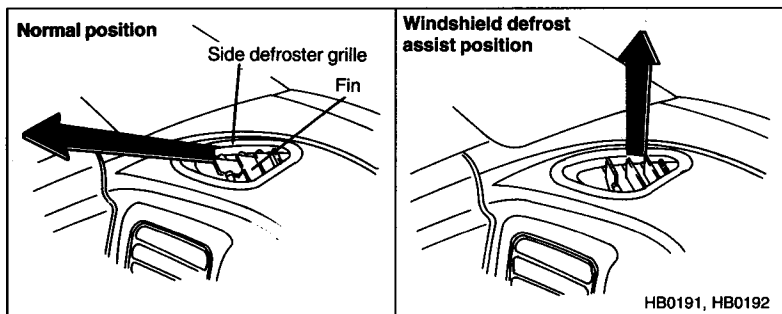

The driver's side defroster grille is adjustable. The normal positions as shown in the diagram directs warm air to the side glass. When more rapid defrosting of the windshield is desired, the air flow can be directed temporarily toward the windshield to assist the windshield

defroster. If this is done, the driver's side grille should always be returned to its normal positions so that the warm air flow can then be used to defrost the driver's side window.

■ Heating and defrosting

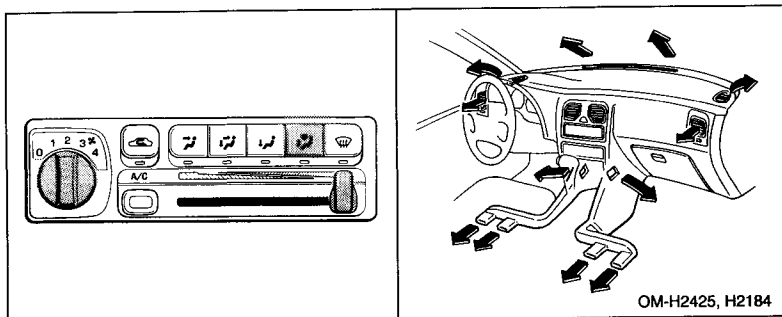

OM-H2425, H2184

To direct warm air toward the floor and the windshield:

1. Push the "  " button in.
2. Set the temperature control lever to the most comfortable level.
3. Set the fan speed control dial to the desired speed.

▼ Adjustable side defroster grille (for driver's side – if equipped)

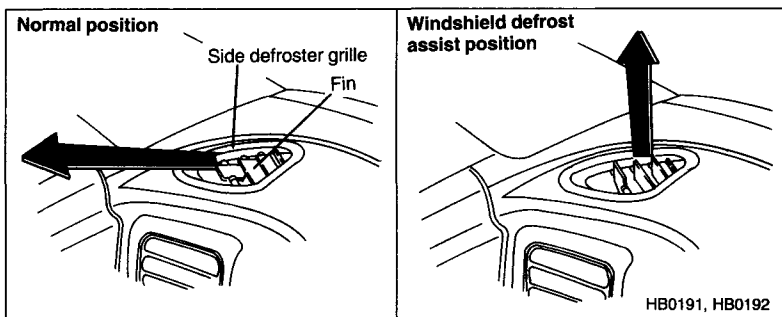

HB0191, HB0192

The driver's side defroster grille is adjustable. The normal positions as shown in the diagram directs warm air to the side glass. When more rapid defrosting of the windshield is desired, the air flow can be

– CONTINUED –

directed temporarily toward the windshield to assist the windshield defroster. If this is done, the driver's side grille should always be returned to its normal positions so that the warm air flow can then be used to defrost the driver's side window.

■ Heating

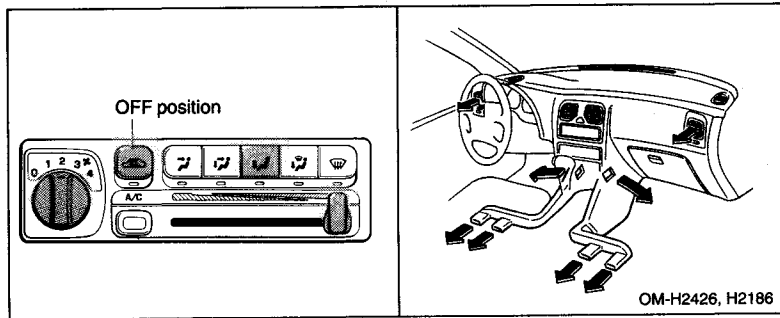

To direct warm air toward the floor:

1. Set the air inlet selection button to the "OFF" position.
2. Push the "  " button in.
3. Set the temperature control lever to the most comfortable level.
4. Set the fan speed control dial to the desired speed.

To stop the warm air coming from the ventilator at each side of the instrument panel, turn each ventilator thumb-wheel to the "  " position.

■ Bi.level heating

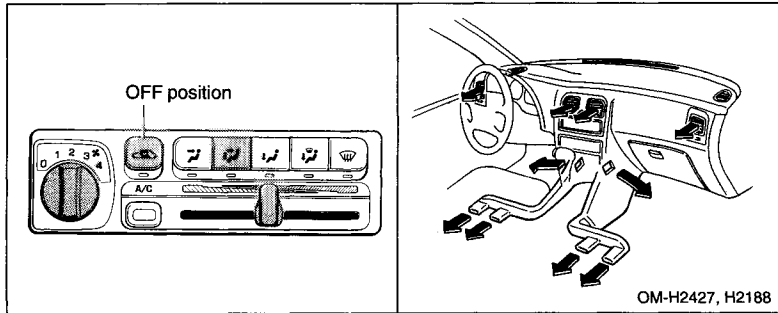

To direct air of different temperatures from the instrument panel outlets and foot outlets. The cool air will flow from the instrument panel outlets and warm air flows from the foot outlets.

1. Set the air inlet selection button to the "OFF" position.
2. Push the "  " button in.
3. Set the temperature control lever to the desired temperature level.
4. Set the fan speed control dial to the desired speed.

Setting the temperature control lever fully turned to the red area or blue area decreases the temperature difference between the air from instrument panel outlets and the air from foot outlets.

■ Ventilation

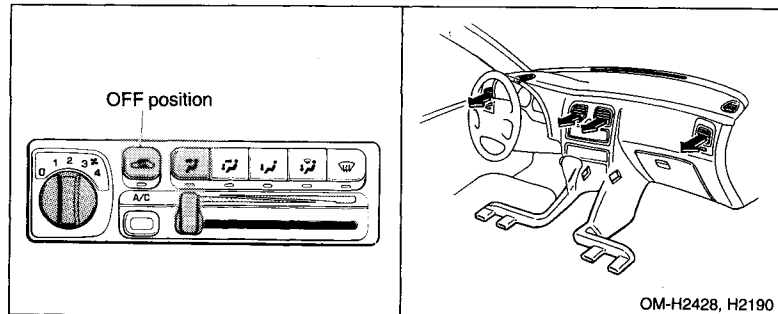

– CONTINUED –

To force outside air through the instrument panel outlets:

1. Set the air inlet selection button to the "OFF" position.
2. Push the "  " position.
3. Set the temperature control lever all the way to the left in the blue area.
4. Set the fan control dial to the desired level.

■ **To shut off the outside air**

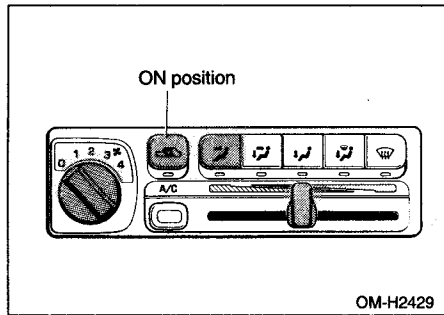

1. Set the fan control dial to the "OFF" position.
2. Set the air inlet selection button to the "ON" position.

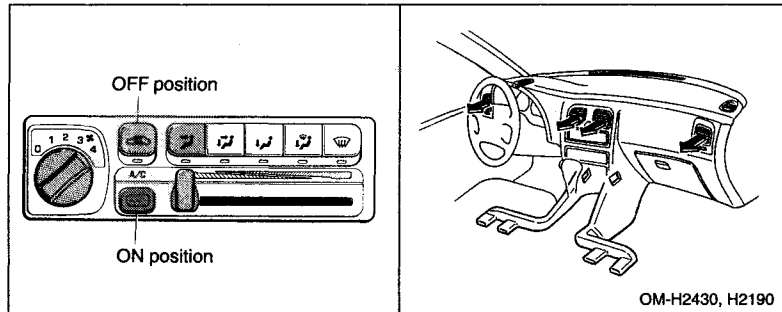
AIR CONDITIONER OPERATION**■ Cooling or dehumidifying**

For cooling and dehumidification of the passenger compartment, air flows through the instrument panel outlets:

1. Set the air inlet selection button to the "OFF" position.
2. Push the "  " button in.
3. Push the air conditioner button on.
4. Set the temperature control lever to the blue area.
5. Set the fan speed control dial to the highest speed.

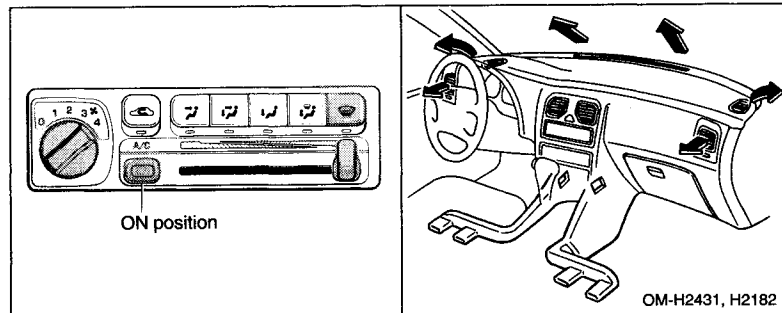
■ Defrosting or defogging

To direct warm air to the windshield and front door windows:

1. Push the "  " button in.

– CONTINUED –

2. Set the temperature control lever to the red area.
3. Set the fan speed control dial to the highest speed.

To stop the warm air coming from the ventilator at each side of the instrument panel, turn each ventilator thumb-wheel to the " ☒ " position.

▼ **Adjustable side defroster grille (for driver's side – if equipped)**

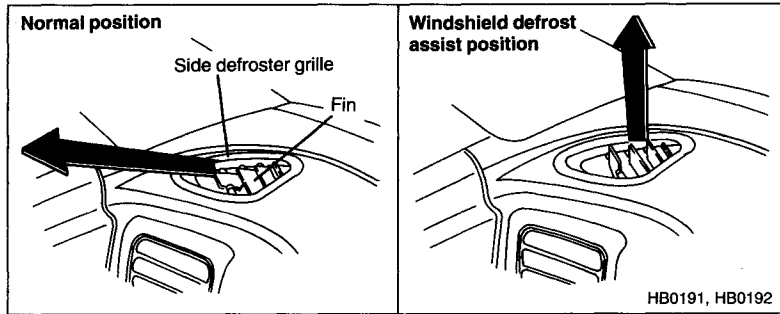

The driver's side defroster grille is adjustable. The normal positions as shown in the diagram directs warm air to the side glass. When more rapid defrosting of the windshield is desired, the air flow can be directed temporarily toward the windshield to assist the windshield defroster. If this is done, the driver's side grille should always be returned to its normal positions so that the warm air flow can then be used to defrost the driver's side window.

OPERATING TIPS FOR HEATER AND AIR CONDITIONER

▼ Cleaning ventilator grille

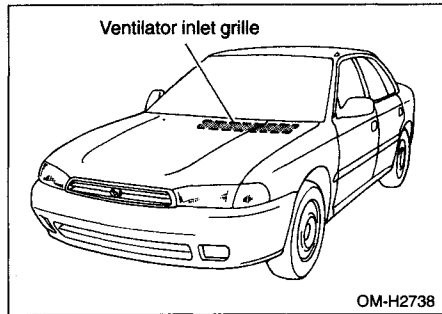

Always keep the front ventilator inlet grille free of snow, leaves, or other obstructions to ensure efficient heating and defrosting. Since the condenser is located in front of the radiator, this area should be kept clean because cooling performance is impaired by any accumulation of insects and leaves on the condenser.

▼ Efficient cooling after parking in direct sunlight

After parking in direct sunlight, drive with the windows open for a few minutes to allow outside air to circulate into the heated interior. This results in quicker cooling by the air conditioner. Keep the windows closed during the operation of the air conditioner for maximum cooling efficiency.

▼ Lubrication oil circulation in the refrigerant circuit

Operate the air conditioner compressor at a low engine speed (at idle or low driving speeds) a few minutes each month during the off-season to circulate its oil.

▼ Checking air conditioning system before summer season

Check the air conditioner unit for refrigerant leaks, hose conditions, and proper operation each spring. This check is best performed by your SUBARU dealer.

- CONTINUED -

▼ **Cooling and dehumidifying in high humidity and low temperature weather condition**

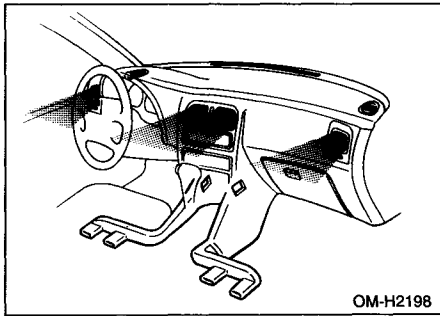

Under certain weather conditions (high relative humidity, low temperatures, etc.) a small amount of water vapor emission from the air outlets may be noticed during cooling or dehumidifying. This condition is normal and does not indicate any problem with the air conditioning system.

▼ **Air conditioner compressor shut-off when engine is heavily loaded**

To improve acceleration and gas mileage, this air conditioner compressor is designed to temporarily shut off during air conditioner operation whenever the accelerator is fully depressed such as at rapid acceleration or driving on a steep upgrade.

▼ **Refrigerant for your climate control system**

Your air conditioner is ozone friendly and uses the refrigerant HFC134a. Therefore, the method of adding, changing or checking the refrigerant is different from the method for CFC12. Consult your SUBARU dealer for service.