

4. Schematic

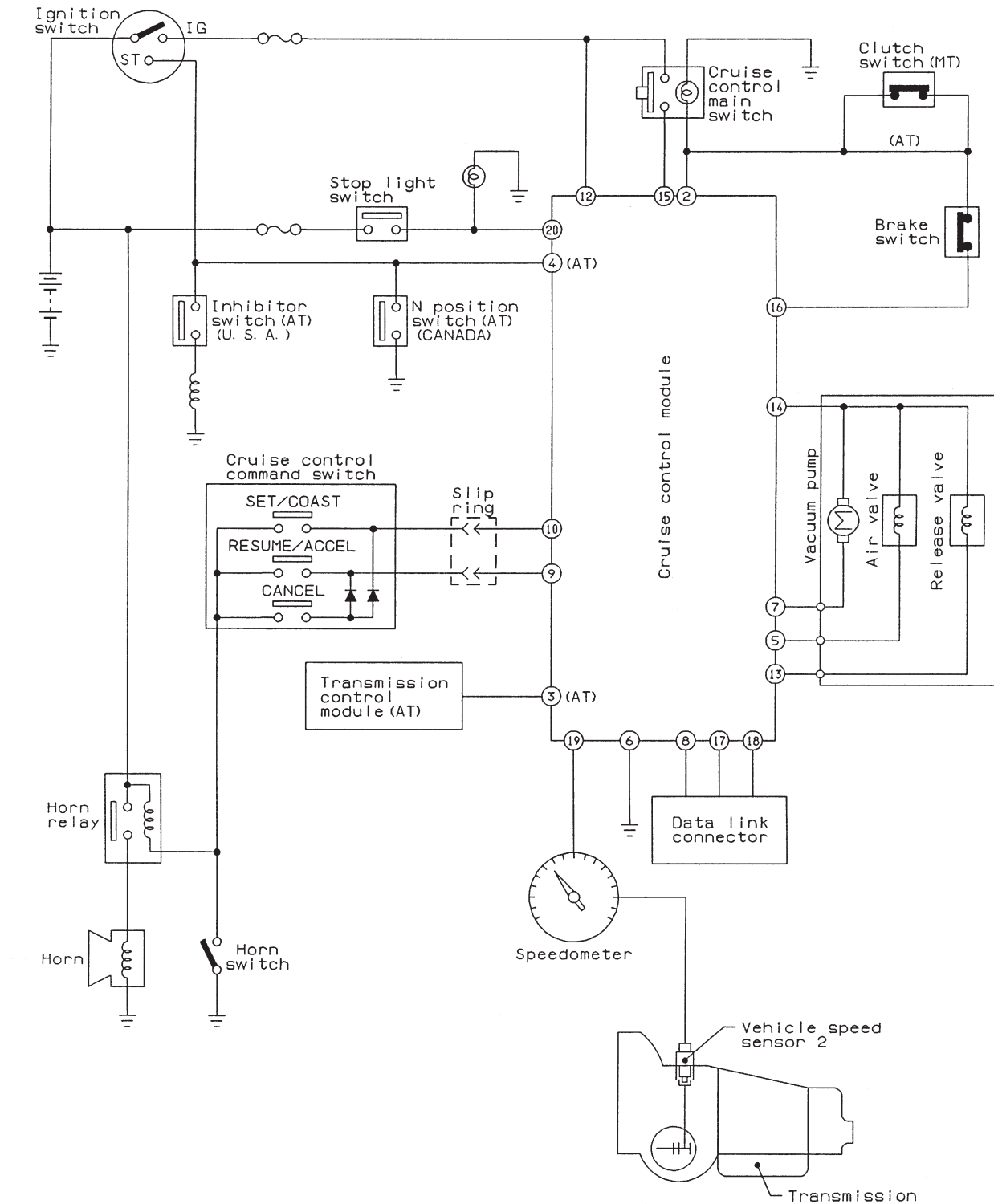

B6M0274