

### 5. Diagnostics Chart with Trouble Code

<Ref. to 5-5 [T4D1].>

#### A: TROUBLE CODE 02

##### DIAGNOSIS:

- Front sensor harness is shorted.
- Airbag main harness is shorted.
- Airbag module harness (Driver or passenger) is shorted.
- Roll connector is shorted.
- Airbag control module is faulty.

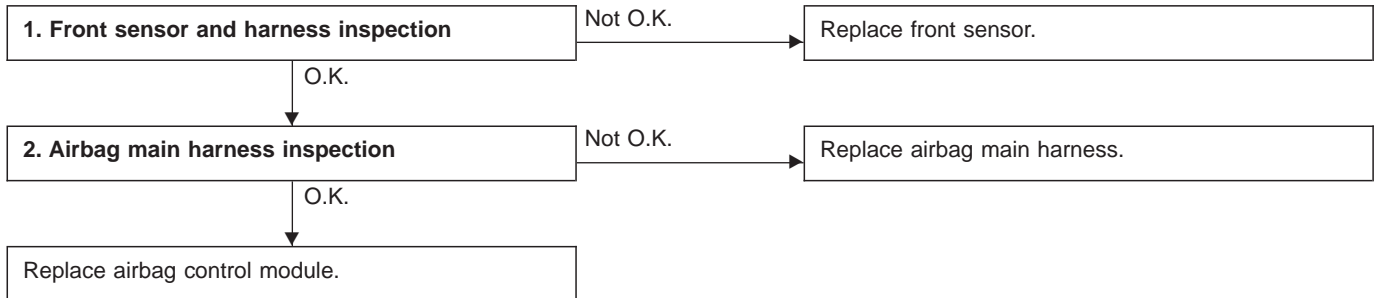

##### CAUTION:

Before performing diagnostics on airbag system, turn ignition switch “OFF”, disconnect battery ground terminal and then wait at least 20 seconds.

After 20 seconds elapse, remove instrument panel lower cover, and disconnect (AB3) and (AB8), (AB9) and (AB10).

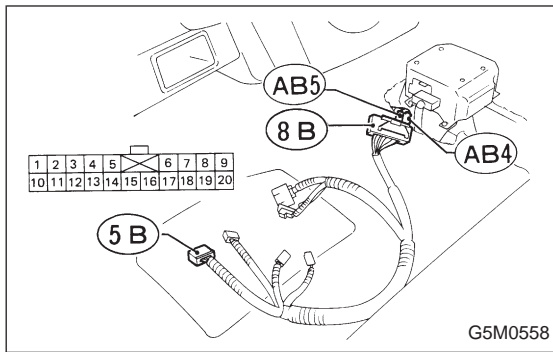

### 1. FRONT SENSOR AND HARNESS INSPECTION

- 1) Disconnect connectors (AB4) and (AB5) from airbag control module. <Ref. to 5-5 [W6A0].>
- 2) Connect connectors (AB4) and (AB5) to connector (8B) of test harness B2.
- 3) Measure resistance between connector (5B) terminal indicated.

#### **(5B) Terminal / Specified resistance:**

**(RH: AB4): No. 17 — No. 18 / 1.4 — 1.6 k $\Omega$**

**(LH: AB5): No. 15 — No. 16 / 1.4 — 1.6 k $\Omega$**

- 4) Measure resistance between each connector (5B) terminal and body.

#### **(5B) Terminal / Specified resistance:**

**(RH: AB4): No. 17 — Body / 1 M $\Omega$ , or more**

**No. 18 — Body / 1 M $\Omega$ , or more**

**(LH: AB5): No. 15 — Body / 1 M $\Omega$ , or more**

**No. 16 — Body / 1 M $\Omega$ , or more**

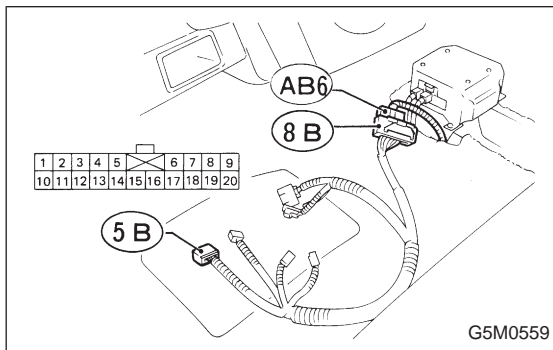

### 2. AIRBAG MAIN HARNESS INSPECTION

- 1) Disconnect connector (AB6) from airbag control module <Ref. to 5-5 [W6A0].>, and connect (AB6) to test harness B2 connector (8B).
- 2) Measure resistance between each (5B) terminal and body.

#### **(5B) Terminal / Specified resistance:**

**No. 1 — Body / 1 M $\Omega$ , or more**

**No. 14 — Body / 1 M $\Omega$ , or more**

**B: TROUBLE CODE 03**

**DIAGNOSIS:**

- Front sensor harness circuit is open.
- Front sensor unit circuit is open.

1. Front sensor (LH and RH) inspection

Identify faulty sensor and replace front sensor.

**CAUTION:**

Before performing the diagnostics on airbag system, turn ignition switch "OFF", disconnect battery ground terminal and then wait at least 20 seconds.

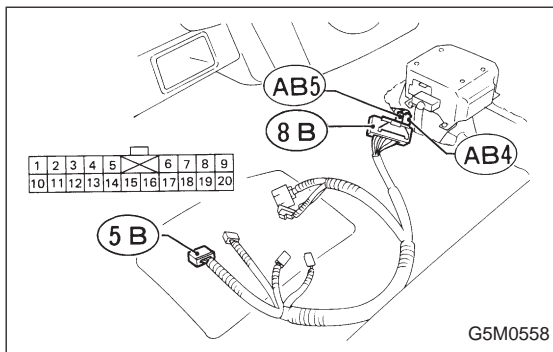

**1. FRONT SENSOR (LH AND RH) INSPECTION**

- 1) Disconnect connectors (AB4) and (AB5) from airbag control module. <Ref. to 5-5 [W6A0].>
- 2) Connect connectors (AB4) and (AB5) to test harness B2 connector (8B).
- 3) Measure resistance between connector (5B) terminal.

**(5B) Terminal / Specified resistance:**

- (RH: AB4): No. 17 — No. 18 / 1.4 — 1.6 kΩ
- (LH: AB5): No. 15 — No. 16 / 1.4 — 1.6 kΩ

**C: TROUBLE CODE 04****DIAGNOSIS:**

- Airbag main harness circuit is shorted.
- Airbag module harness (Passenger) circuit is shorted.
- Airbag control module is faulty.

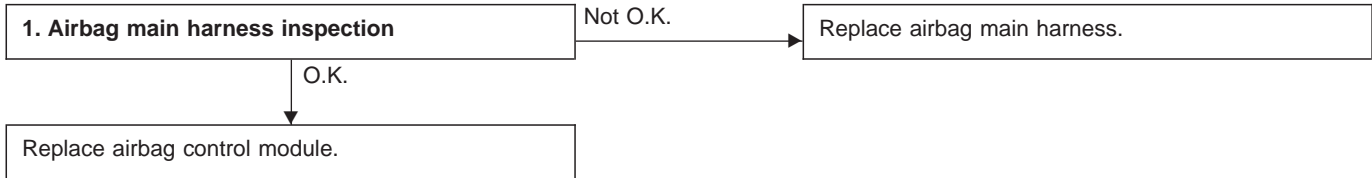
**CAUTION:**

Before performing diagnostics on airbag system, turn ignition switch "OFF", disconnect battery ground cable and then wait at least 20 seconds.

After 20 seconds elapse, remove instrument panel lower cover, and disconnect (AB3) and (AB8), (AB9) and (AB10).

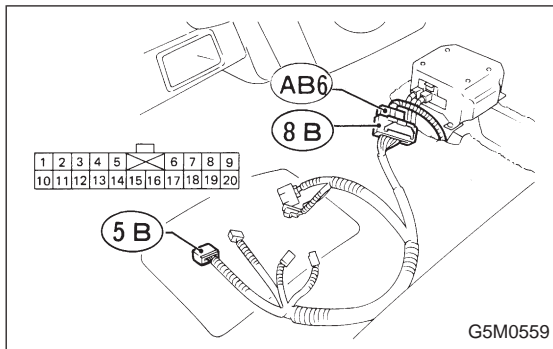
**1. AIRBAG MAIN HARNESS INSPECTION**

1) Disconnect connector (AB6) from airbag control module <Ref. to 5-5 [W6A0].>, and connect it to test harness B2 connector (8B).

2) Measure resistance between test harness B2 connector (5B) terminal.

**(5B) Terminal / Specified resistance:**  
**No. 6 — No. 7 / 10 kΩ, or more**

**D: TROUBLE CODE 11**

**DIAGNOSIS:**

- Airbag control module is faulty.
- Airbag main harness circuit is open.
- Fuse No. 8 is blown.
- Body harness circuit is open.



**CAUTION:**

Before performing diagnostics on airbag system, turn ignition switch “OFF”, disconnect battery ground cable and then wait at least 20 seconds.

After 20 seconds elapse, remove instrument panel lower cover, and disconnect (AB3) and (AB8), (AB9) and (AB10).

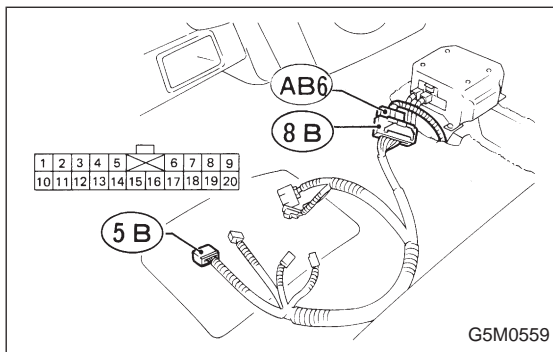

**1. AIRBAG CONTROL MODULE INSPECTION**

1) Disconnect connector (AB6) from airbag control module <Ref. to 5-5 [W6A0].> and connect it to test harness B2 connector (8B).

2) Connect battery ground cable and turn ignition switch “ON”. (engine off)

3) Measure voltage across connector (5B) terminal and body.

**(5B) Terminal / Specified voltage:**

**No. 2 — Body / 10 V, or more**

**2. AIRBAG MAIN HARNESS INSPECTION**

1) Go to step 2) below after performing diagnostics on airbag system as per flowchart under “**1. AIRBAG CONTROL MODULE INSPECTION**” previously outlined.

2) Turn ignition switch “OFF”, disconnect battery ground terminal and then wait at least 20 seconds.

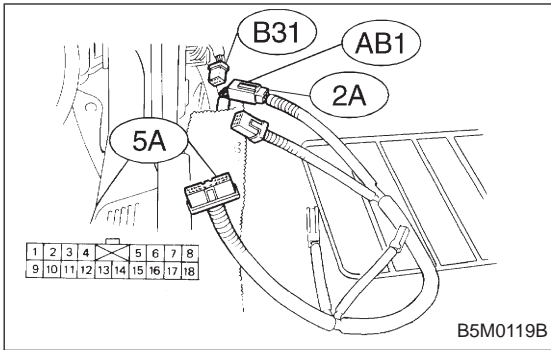

3) Disconnect body harness connector (B31) from connector (AB1) at front lower pillar, and connect connector (AB1) to test harness A connector (2A).

4) Measure resistance between test harness A connector (5A) terminal and test harness B2 connector (5B) terminal.

**Connector & terminal / Specified resistance:**

**(5A) No. 1 — (5B) No. 2 / 10  $\Omega$ , or less**

5) Measure resistance between terminals of connectors (5A) and (5B).

**(5A) Terminal / Specified resistance:**

**No. 1 — Body / 10  $k\Omega$ , or more**

**(5B) Terminal / Specified resistance:**

**No. 2 — Body / 10  $k\Omega$ , or more**

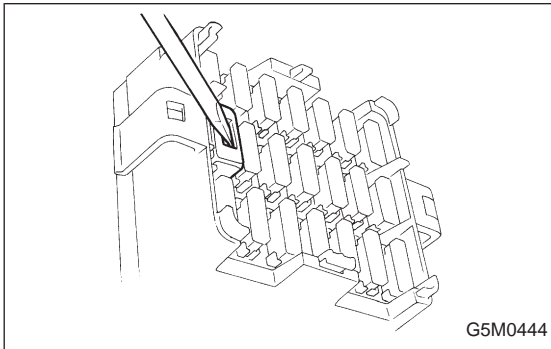

### 3. FUSE No. 8 INSPECTION

1) Turn ignition switch "OFF", and remove airbag fuse protector.

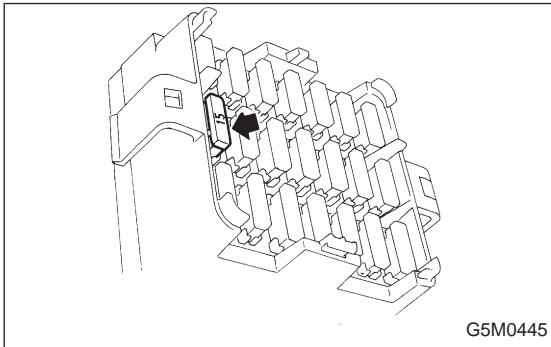

2) Remove and visually check fuse No. 8.

**E: TROUBLE CODE 12**

**DIAGNOSIS:**

- Airbag main harness circuit is open.
- Airbag module harness (Driver) circuit is open.
- Roll connector circuit is open.
- Airbag control module is faulty.

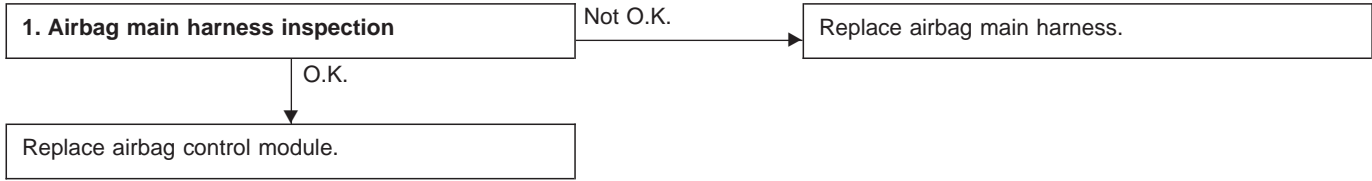

**CAUTION:**

Before performing diagnostics on airbag system, turn ignition switch "OFF", disconnect battery ground cable and then wait at least 20 seconds.

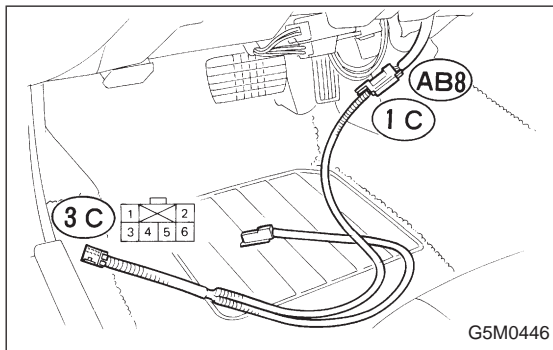

**1. AIRBAG MAIN HARNESS INSPECTION**

1) Remove lower cover panel <Ref. to 5-4 [W1A0].>, and connect connector (AB8) below steering column to test harness C connector (1C).

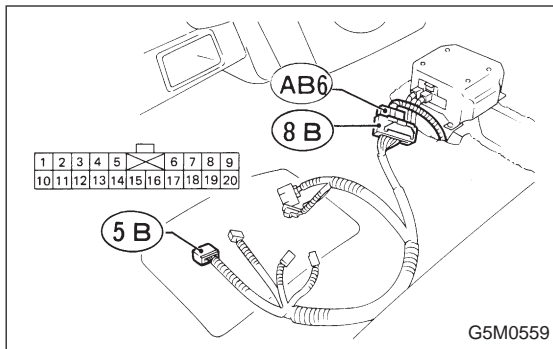

2) Disconnect connector (AB6) <Ref. to 5-5 [W6A0].> from airbag control module, and connect it to test harness B2 connector (8B) terminal.

3) Measure resistance between test harness B2 connector (5B) and test harness C connector (3C) terminals.

**Connector & terminal / Specified resistance:**

(5B) No. 14 — (3C) No. 4 / 10 Ω, or less

(5B) No. 1 — (3C) No. 3 / 10 Ω, or less

**F: TROUBLE CODE 13****DIAGNOSIS:**

- Airbag main harness circuit is shorted.
- Airbag module harness (Driver) is shorted.
- Roll connector circuit is shorted.
- Airbag control module is faulty.

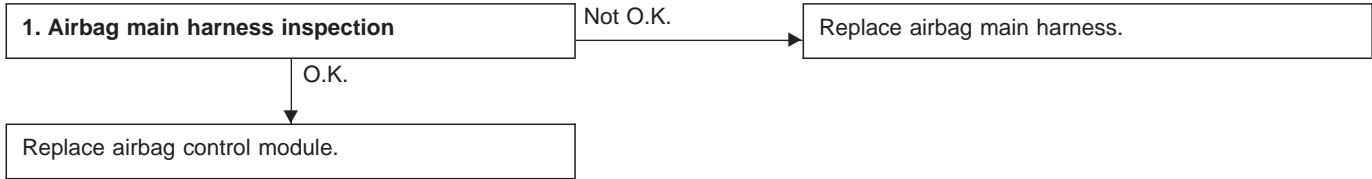
**CAUTION:**

Before performing diagnostics on airbag system, turn ignition switch "OFF", disconnect battery ground cable and then wait at least 20 seconds.

After 20 seconds elapse, remove instrument panel lower cover, and disconnect (AB3) and (AB8), (AB9) and (AB10).

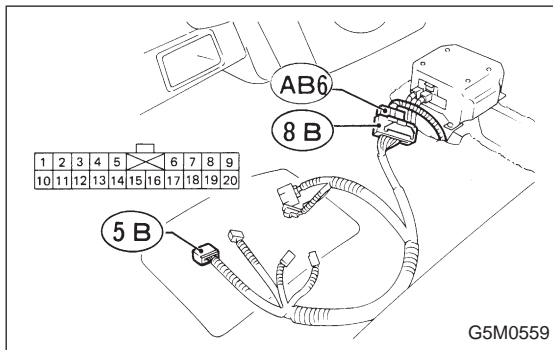
**1. AIRBAG MAIN HARNESS INSPECTION**

1) Disconnect connector (AB6) from airbag control module <Ref. to 5-5 [W6A0].>, and connect it to test harness B2 connector (8B).

2) Measure resistance between test harness B2 connector (5B) terminal.

**(5B) Terminal / Specified resistance:**  
**No. 1 — No. 14 / 10 kΩ, or more**



**G: TROUBLE CODE 14**

**DIAGNOSIS:**

- (AB9) and (AB10) are not connected properly.
- (AB2) and (AB7) are not connected properly.
- (AB3) and (AB8) are not connected properly.
- (AB4), (AB5) and (AB6) are not connected properly to airbag control module.

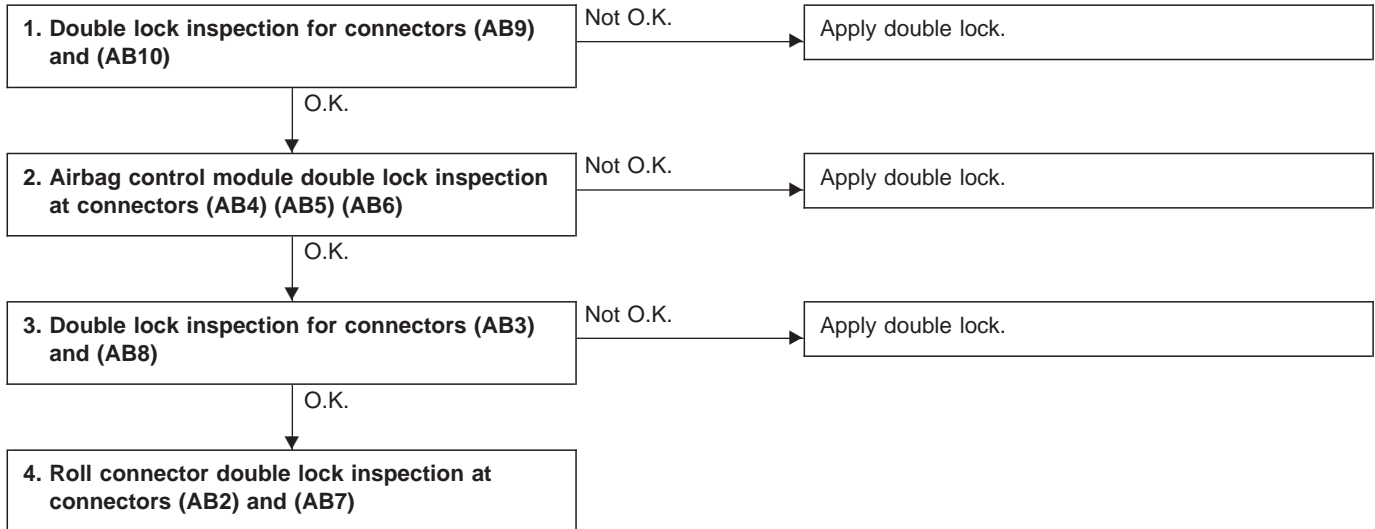

**CAUTION:**

Before performing diagnostics on airbag system, turn ignition switch "OFF", disconnect battery ground cable and then wait at least 20 seconds.

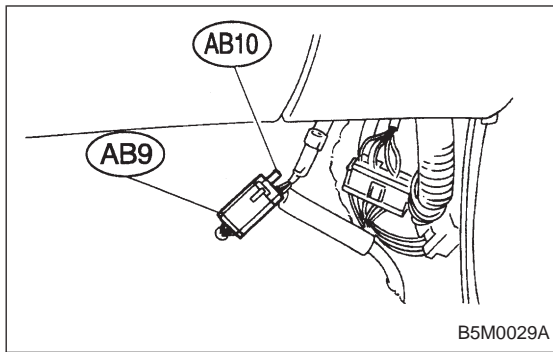

### 1. DOUBLE LOCK INSPECTION FOR CONNECTORS (AB9) AND (AB10)

- 1) Remove front pillar lower trim (Passenger side). <Ref. to 5-3 [W5A1].>
- 2) Check double lock of connectors (AB9) and (AB10).

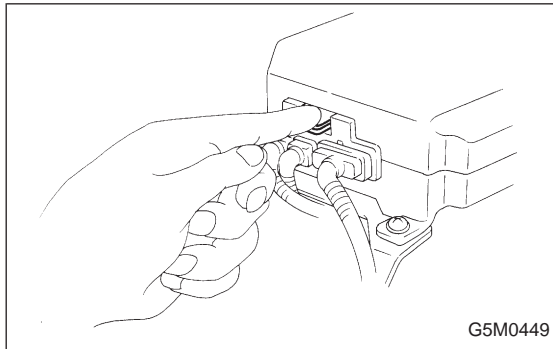

### 2. AIRBAG CONTROL MODULE DOUBLE LOCK INSPECTION AT CONNECTORS (AB4) (AB5) (AB6)

Check double lock of connectors (AB4) (AB5) (AB6) connected to airbag control module. <Ref. to 5-5 [W6A0].>

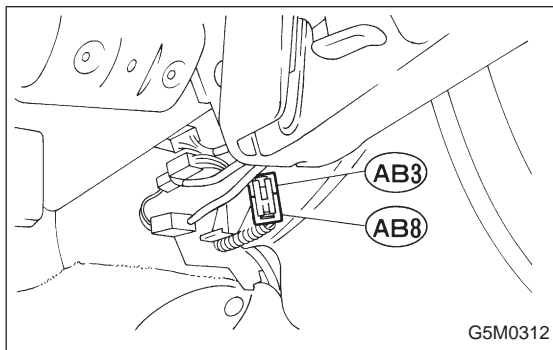

### 3. DOUBLE LOCK INSPECTION FOR CONNECTORS (AB3) AND (AB8)

- 1) Remove lower cover panel. <Ref. to 5-4 [W1A0].>
- 2) Check double lock of connectors (AB3) and (AB8) below steering column.

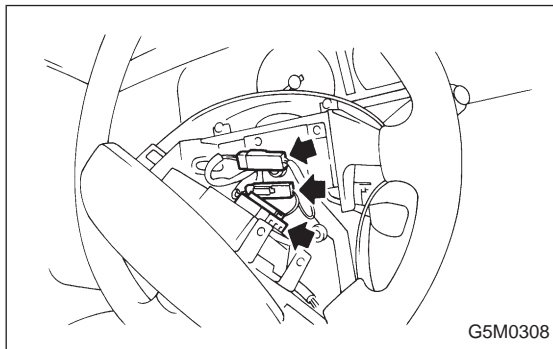

### 4. ROLL CONNECTOR DOUBLE LOCK INSPECTION AT CONNECTORS (AB2) AND (AB7)

Remove driver side airbag module <Ref. to 5-5 [W3A1].>, and check double lock of connectors (AB2) and (AB7) at roll connector.

**H: TROUBLE CODE 21****DIAGNOSIS:**

- Airbag control module is faulty.

Replace airbag control module.
--------------------------------

**CAUTION:**

**Before performing diagnostics on airbag system, turn ignition switch "OFF", disconnect battery ground terminal, and then wait at least 20 seconds. <Ref. to 5-5 [W6A0].>**

**I: TROUBLE CODE 22****DIAGNOSIS:**

- Airbag main harness circuit is open.
- Airbag module harness (Passenger) circuit is open.
- Airbag control module is faulty.

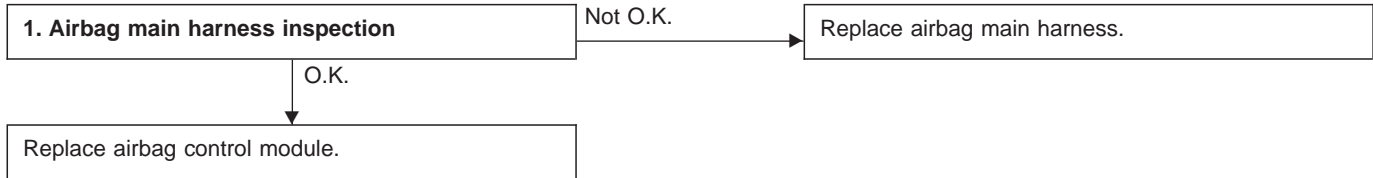
**CAUTION:**

Before performing diagnostics on airbag system, turn ignition switch "OFF", disconnect battery ground cable and then wait at least 20 seconds.

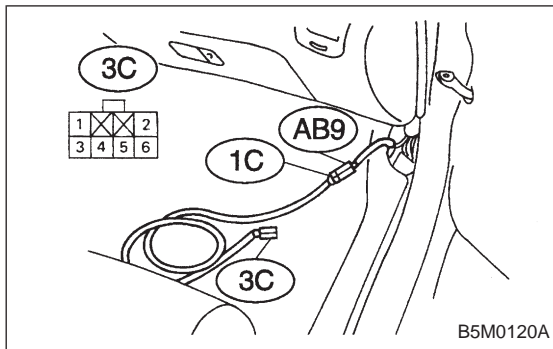
**1. AIRBAG MAIN HARNESS INSPECTION**

1) Remove front pillar lower trim (Passenger side). <Ref. to 5-3 [W5A1].>, disconnect connector (AB9) and (AB10) and connect connector (AB9) to test harness C connector (1C).

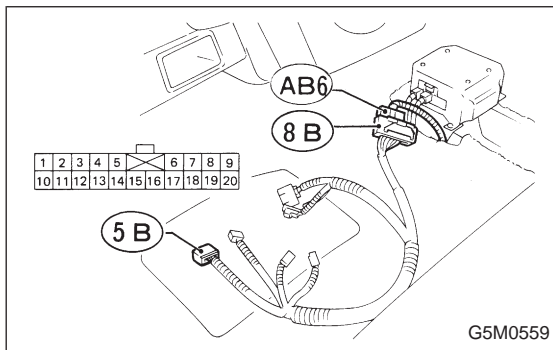

2) Disconnect connector (AB6) <Ref. to 5-5 [W6A0].> from airbag control module, and connect it to test harness B2 connector (8B) terminal.

3) Measure resistance between test harness B2 connector (5B) and test harness C connector (3C) terminals.

**Connector & terminal / Specified resistance:**

(5B) No. 6 — (3C) No. 4 / 10 Ω, or less

(5B) No. 7 — (3C) No. 3 / 10 Ω, or less

**J: TROUBLE CODE 23**

**DIAGNOSIS:**

- Airbag main harness is shorted to power supply.
- Front sensor harness is shorted to power supply.
- Airbag module harness (Driver or passenger) is damaged.
- Roll connector is shorted to power supply.
- Airbag control module is faulty.

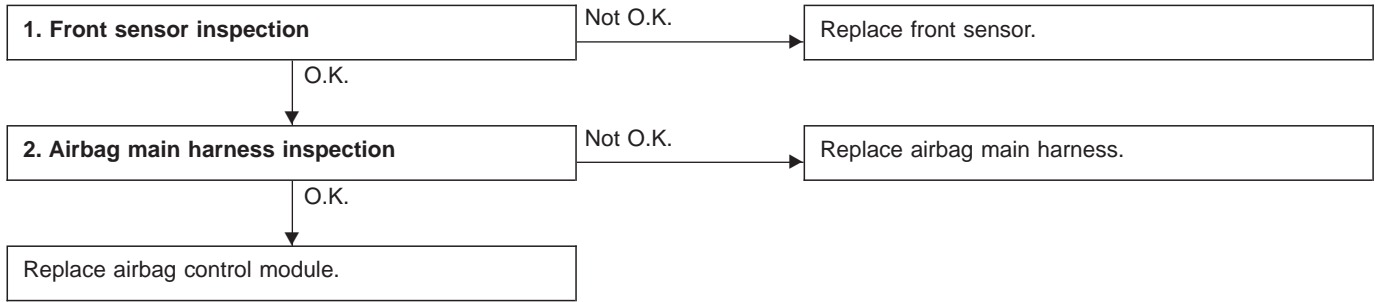

**CAUTION:**

Before performing diagnostics on airbag system, turn ignition switch "OFF", disconnect battery ground terminal and then wait at least 20 seconds.

After 20 seconds elapse, remove instrument panel lower cover, and disconnect (AB3) and (AB8), (AB9) and (AB10).

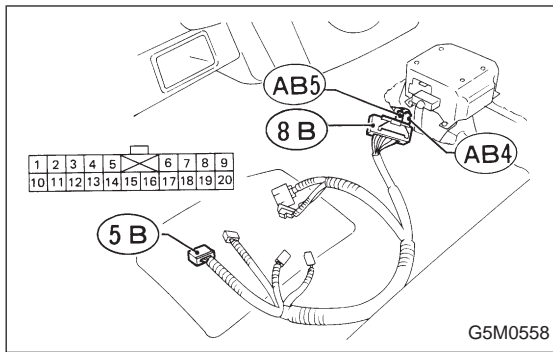

### 1. FRONT SENSOR INSPECTION

- 1) Disconnect connectors (AB4) and (AB5) from airbag control module. <Ref. to 5-5 [W6A0].>
- 2) Connect connectors (AB4) and (AB5) to test harness B2 connector (8B).
- 3) Measure resistance between test harness B2 connector (5B) terminal.

#### **(5B) Terminal / Specified resistance:**

**(RH: AB4): No. 17 — No. 18 / 1.4 — 1.6 k $\Omega$**

**(LH: AB5): No. 15 — No. 16 / 1.4 — 1.6 k $\Omega$**

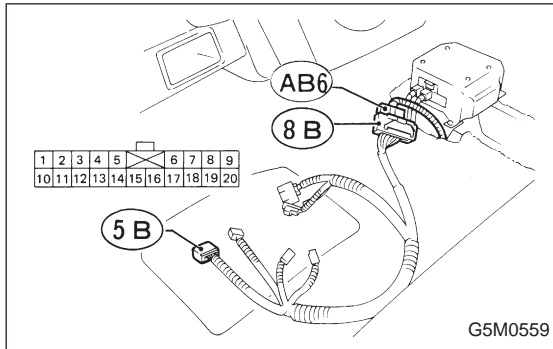

### 2. AIRBAG MAIN HARNESS INSPECTION

- 1) Disconnect connector (AB6) from airbag control module <Ref. to 5-5 [W6A0].>, and connect it to test harness B2 connector (8B).
- 2) Connect battery ground cable and turn ignition switch "ON" (engine off).
- 3) Measure voltage across each test harness B2 connector (5B) terminal and body.

#### **(5B) Terminal / Specified voltage:**

**No. 1 — Body / 1 V, or less**

**No. 6 — Body / 1 V, or less**

**No. 7 — Body / 1 V, or less**

**No. 14 — Body / 1 V, or less**

**K: TROUBLE CODE 24**

**DIAGNOSIS:**

- Airbag main harness circuit is open.
- Airbag module harness (Driver) circuit is open.
- Roll connector circuit is open.
- Airbag control module is faulty.
- Above diagnosis plus other faulty of airbag modular parts

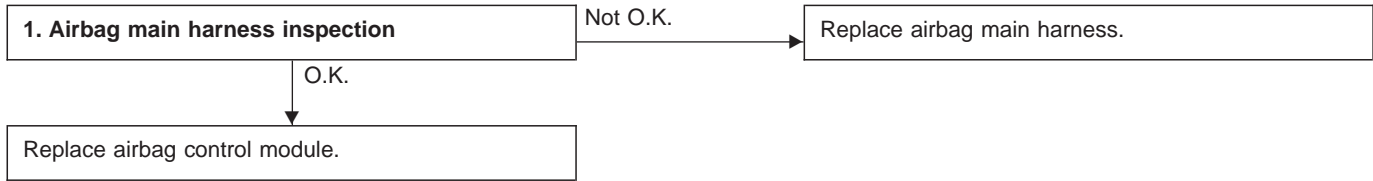

**CAUTION:**

**Before performing diagnostics on airbag system, turn ignition switch "OFF", disconnect battery ground cable and then wait at least 20 seconds.**

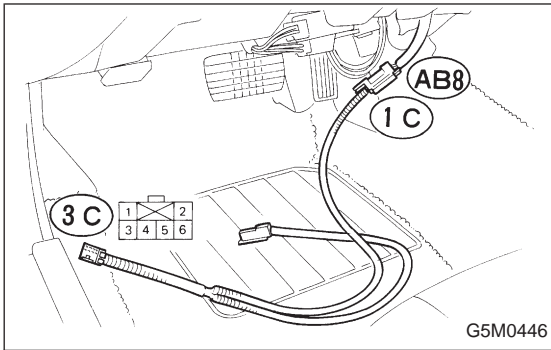

### 1. AIRBAG MAIN HARNESS INSPECTION

1) Remove lower cover panel <Ref. to 5-4 [W1A0].>, and connect connector (AB8) below steering column to test harness C connector (1C).

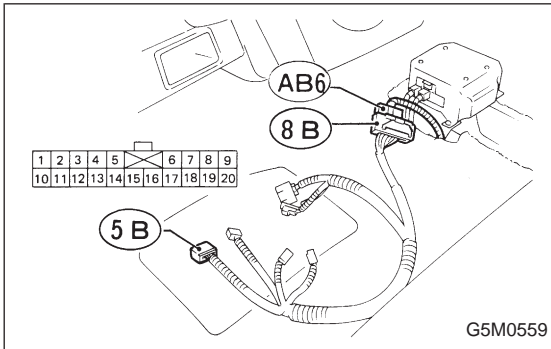

2) Disconnect connector (AB6) <Ref. to 5-5 [W6A0].> from airbag control module, and connect it to test harness B2 connector (8B) terminal.

3) Measure resistance between test harness B2 connector (5B) and test harness C connector (3C) terminals.

#### **Connector & terminal / Specified resistance:**

**(5B) No. 14 — (3C) No. 4 / 10 Ω, or less**

**(5B) No. 1 — (3C) No. 3 / 10 Ω, or less**



**L: TROUBLE CODE 31**

**DIAGNOSIS:**

- Airbag control module is faulty.
- Airbag main harness circuit is open.
- Fuse No. 16 is blown.
- Body harness circuit is open.

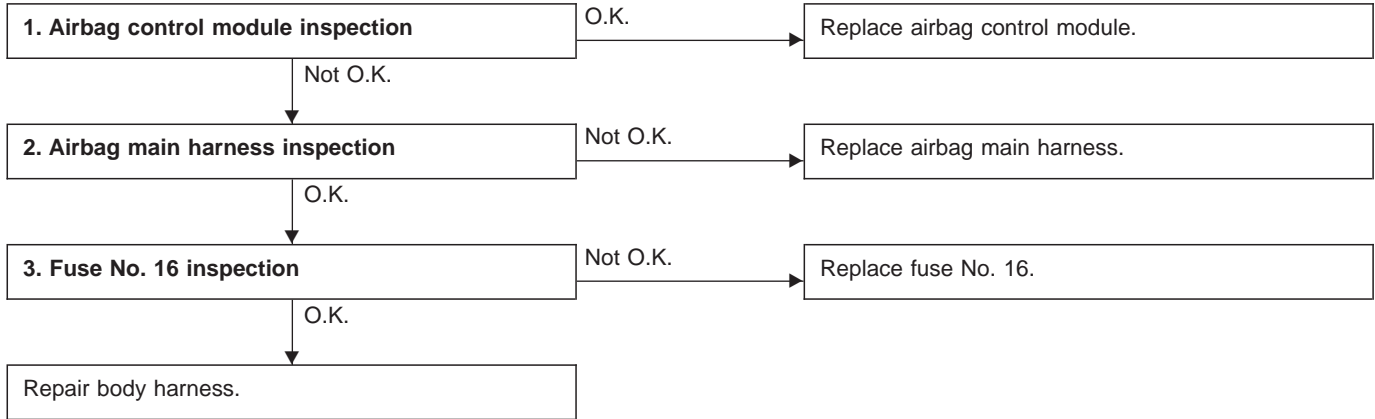

**CAUTION:**

Before performing diagnostics on airbag system, turn ignition switch “OFF”, disconnect battery ground cable and then wait at least 20 seconds.

After 20 seconds elapse, remove instrument panel lower cover, and disconnect (AB3) and (AB8), (AB9) and (AB10).

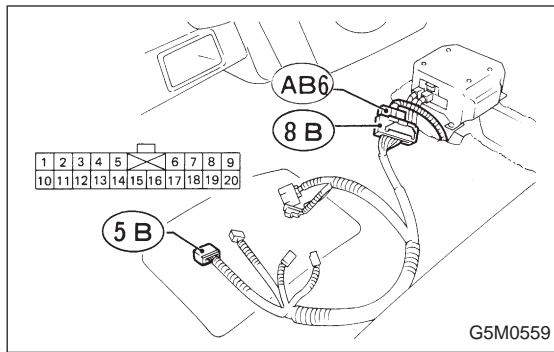

### 1. AIRBAG CONTROL MODULE INSPECTION

1) Disconnect connector (AB6) from airbag control module <Ref. to 5-5 [W6A0].>, and connect it to test harness B2 connector (8B).

2) Connect battery ground cable and turn ignition switch "ON" (engine off).

3) Measure voltage across connector (5B) terminal and body.

**(5B) Terminal / Specified voltage:**  
**No. 5 — Body / 10 V, or more**

### 2. AIRBAG MAIN HARNESS INSPECTION

1) Go to step 2) below after performing diagnostics on airbag system as per flowchart under "1. AIRBAG CONTROL MODULE INSPECTION" previously outlined.

2) Turn ignition switch "OFF", disconnect battery ground cable and then wait at least 20 seconds.

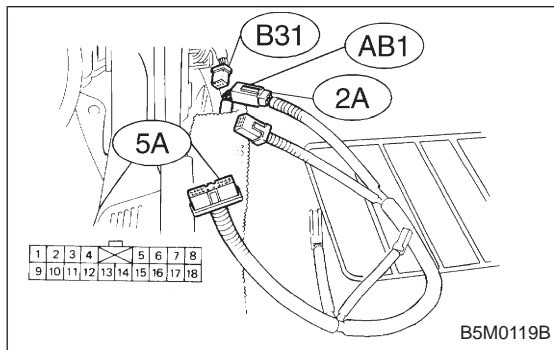

3) Disconnect connector (AB1) from body harness connector (B31) at front lower pillar, and connect connector (AB1) to test harness A connector (2A).

4) Measure resistance between test harness A connector (5A) and test harness B2 connector (5B) terminals.

**Connector & terminal / Specified resistance:**  
**(5A) No. 9 — (5B) No. 5 / 10 Ω, or less**

5) Measure resistance between each terminal of connectors (5A) and (5B) and body.

**(5A) Terminal / Specified resistance:**  
**No. 9 — Body / 10 kΩ, or more**

**(5B) Terminal / Specified resistance:**  
**No. 5 — Body / 10 kΩ, or more**

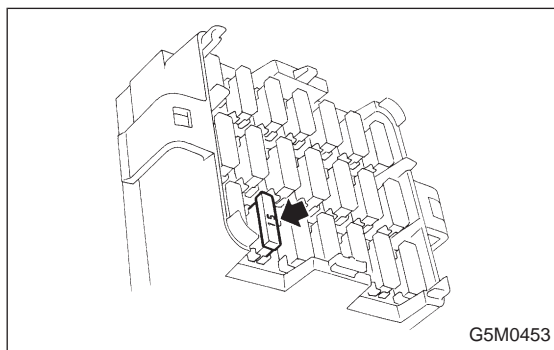

### 3. FUSE No. 16 INSPECTION

Make sure ignition switch is turned "OFF", then remove and visually check fuse No. 16.

**M: TROUBLE CODE 32**

**DIAGNOSIS:**

- Airbag main harness circuit is open.
- Airbag module harness (Passenger) circuit is open.
- Airbag control module is faulty.
- Above diagnosis plus other faulty of airbag modular parts

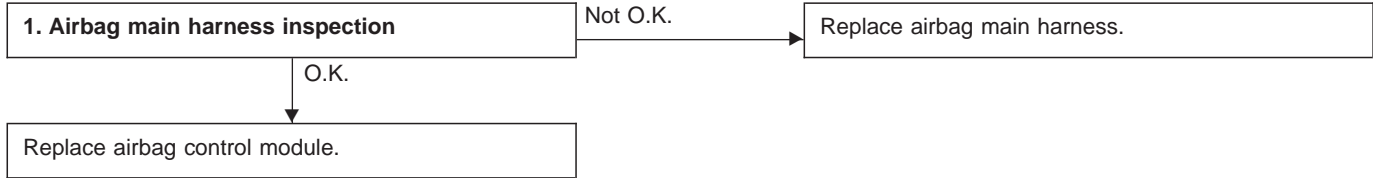

**CAUTION:**

**Before performing diagnostics on airbag system, turn ignition switch "OFF", disconnect battery ground cable and then wait at least 20 seconds.**

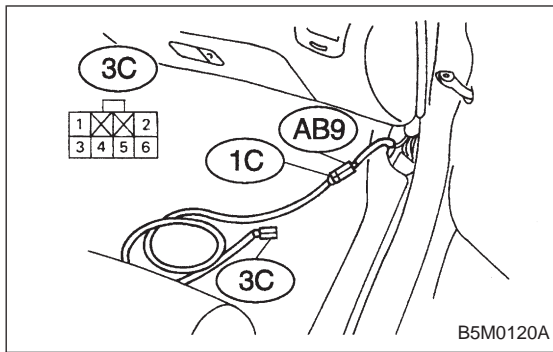

### 1. AIRBAG MAIN HARNESS INSPECTION

1) Remove front pillar lower trim (Passenger side). <Ref. to 5-3 [W5A1].>, disconnect connector (AB9) and (AB10) and connect connector (AB9) to test harness C connector (1C).

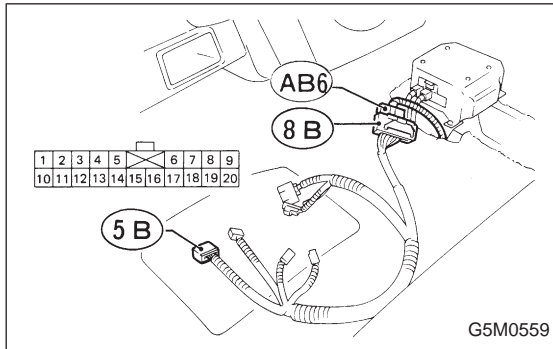

2) Disconnect connector (AB6) <Ref. to 5-5 [W6A0].> from airbag control module, and connect it to test harness B2 connector (8B) terminal.

3) Measure resistance between test harness B2 connector (5B) and test harness C connector (3C) terminals.

#### **Connector & terminal / Specified resistance:**

**(5B) No. 6 — (3C) No. 4 / 10 Ω, or less**

**(5B) No. 7 — (3C) No. 3 / 10 Ω, or less**

**N: AIRBAG WARNING LIGHT REMAINS ON.**

**DIAGNOSIS:**

- Airbag warning light is faulty.
- Airbag control module to airbag warning light harness circuit is shorted or open.
- Grounding circuit is faulty.
- Airbag control module is faulty.
- (AB1) and (B31) are not connected properly.

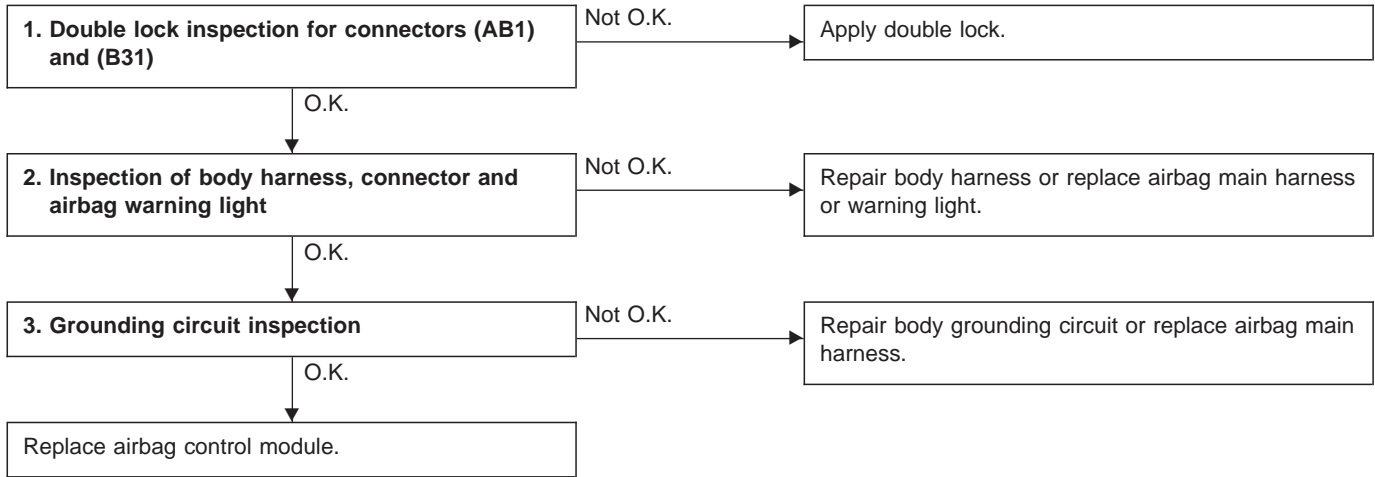

**CAUTION:**

Before performing diagnostics on airbag system, turn ignition switch “OFF”, disconnect battery ground cable and then wait at least 20 seconds.

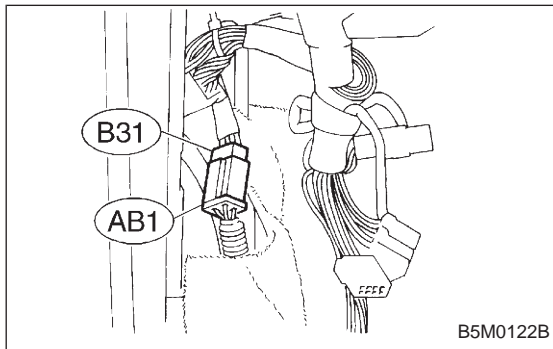

**1. DOUBLE LOCK INSPECTION FOR CONNECTORS (AB1) AND (B31)**

- 1) Remove front pillar lower trim (Driver side).
- 2) Check double lock of connectors (AB1) and (B31).

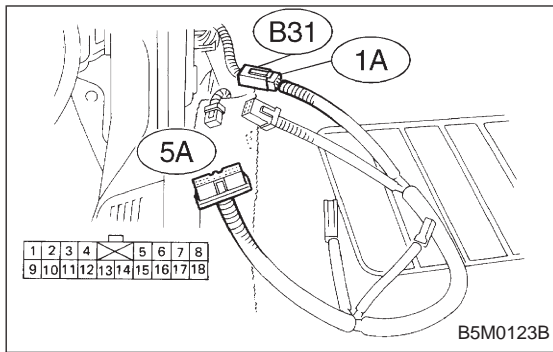

## 2. INSPECTION OF BODY HARNESS, CONNECTOR AND AIRBAG WARNING LIGHT

1) Turn ignition switch "OFF" and connect body harness connector (B31) to test connector (1A).

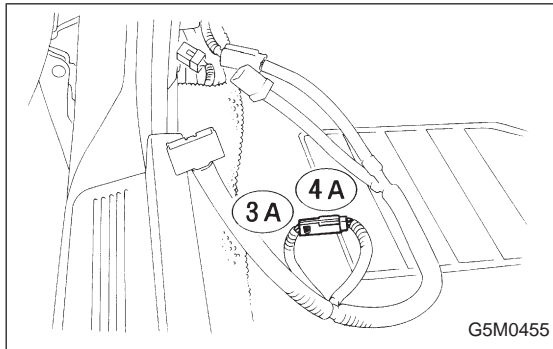

2) Connect battery ground cable and turn ignition switch "ON", (engine off) and connect connectors (3A) and (4A) to check if warning light goes out. If it does, go to step 4) below. If it remains on, check body harness and repair if necessary.

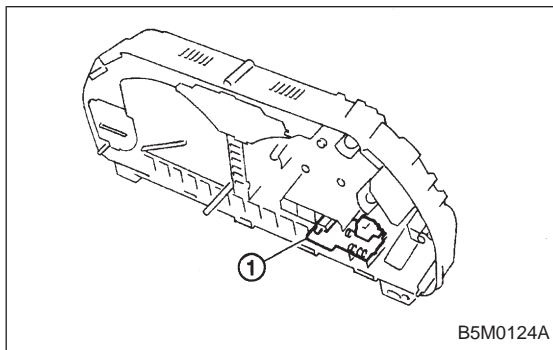

3) If body harness is satisfactory, replace airbag warning light module ①. After problem has been eliminated, disconnect connectors (3A) and (4A).

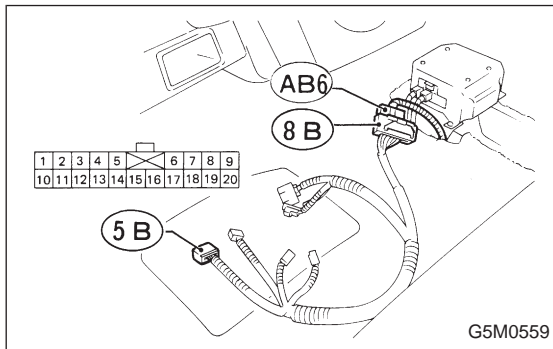

4) Turn ignition switch "OFF", disconnect battery ground cable and then wait at least 20 seconds, and re-connect connectors (AB1) and (B31).

5) Remove instrument panel lower cover and disconnect (AB3) with (AB8), then disconnect connector (AB6) from airbag control module, <Ref. to 5-5 [W6A0].> and connect it to test harness B2 connector (8B).

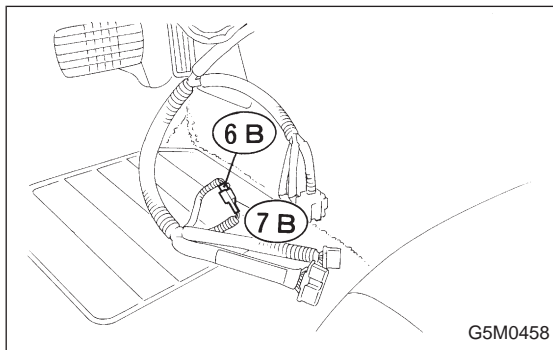

6) Connect battery ground cable and turn ignition switch "ON," (engine off) and connect connectors (6B) and (7B) to check if warning light goes out. If it does, go to "3. GROUNDING CIRCUIT INSPECTION". If it remains on, replace airbag main harness. After problem has been eliminated, disconnect connectors (6B) and (7B).

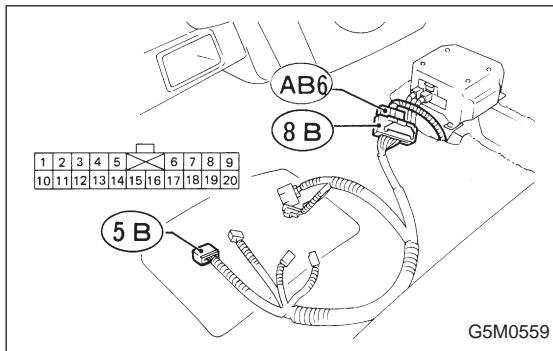
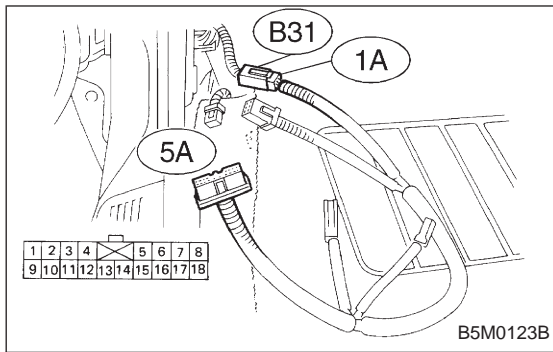

**3. GROUNDING CIRCUIT INSPECTION**

1) Turn ignition switch “OFF”, disconnect battery ground cable and then wait at least 20 seconds. Disconnect connector (AB1) from body harness connector (B31), and connect connector (B31) to test harness A connector (1A). Measure resistance between connector (5A) terminal and body.

**(5A) Terminal / Specified resistance:**  
**No. 17 — Body / 10 Ω, or less**  
**No. 18 — Body / 10 Ω, or less**

If resistance is greater than 10 ohms, body grounding circuit is faulty and should be repaired. If resistance is less than 10 ohms, go to step 2) below.

2) Connect connectors (AB1) and (B31). Disconnect connector (AB6) from airbag control module <Ref. to 5-5 [W6A0].>, and connect it to test harness B2 connector (8B).

3) Measure resistance between each test harness B2 connector (5B) terminal and body.

**(5B) Terminal / Specified resistance:**  
**No. 11 — Body / 10 Ω, or less**  
**No. 12 — Body / 10 Ω, or less**

If resistance is greater than 10 ohms, replace airbag main harness.

If resistance is less than 10 ohms, replace airbag control module.

**O: AIRBAG WARNING LIGHT REMAINS OFF.****DIAGNOSIS:**

- Fuse No. 15 is blown.
- Body harness circuit is open.
- Airbag warning light is faulty.
- Airbag main harness is faulty.
- Airbag control module is faulty.

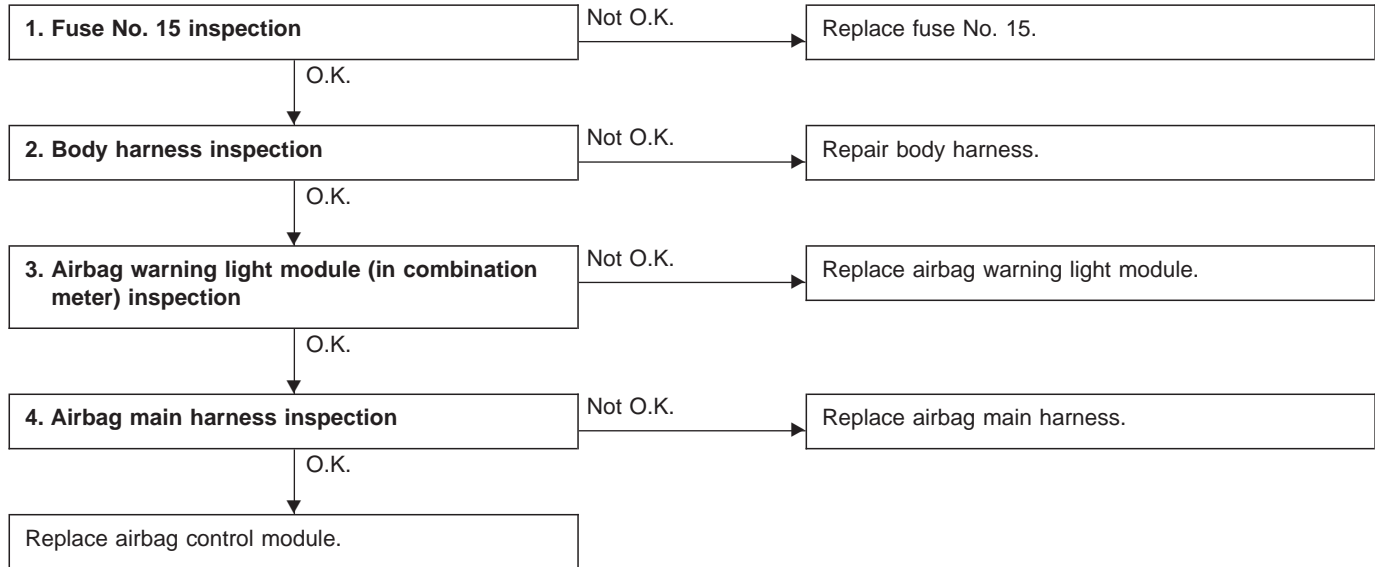
**CAUTION:**

Before performing diagnostics on airbag system, turn ignition switch “OFF”, disconnect battery ground terminal, and then wait at least 20 seconds.

**1. FUSE No. 15 INSPECTION**

- 1) Remove and visually check fuse No. 15.
- 2) If fuse is blown, replace it with a new one. After connecting battery cable and turning ignition switch “ON”, if it blows again, proceed to “**2. BODY HARNESS INSPECTION**”.

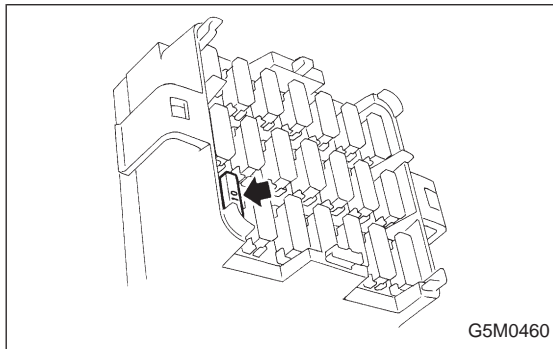
**2. BODY HARNESS INSPECTION**

Turn ignition switch “ON” (engine off) to make sure other warning lights (in combination meter) illuminate. If they do not, check body harness.



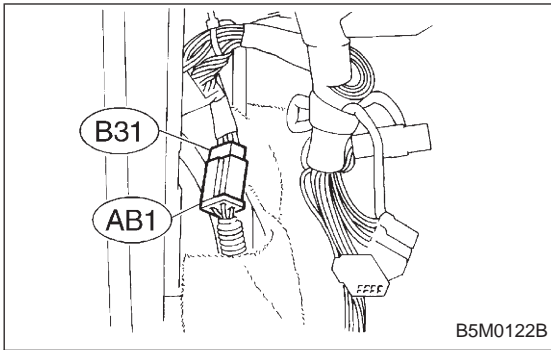

**3. AIRBAG WARNING LIGHT MODULE (IN COMBINATION METER) INSPECTION**

- 1) Turn ignition switch "OFF", disconnect battery ground cable and then wait at least 20 seconds.
- 2) Disconnect body harness connector (B31) from connector (AB1).

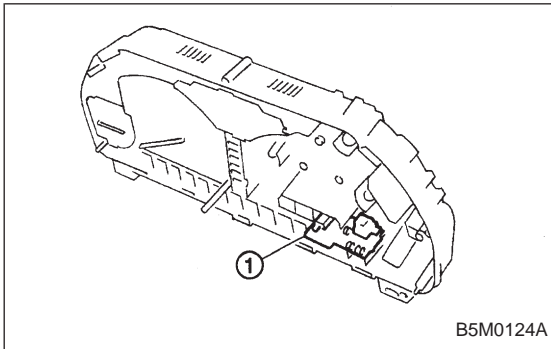

- 3) Connect battery ground cable and turn ignition switch "ON" (engine off) to make sure airbag warning light illuminates.
- If it does not, replace airbag warning light module ①.

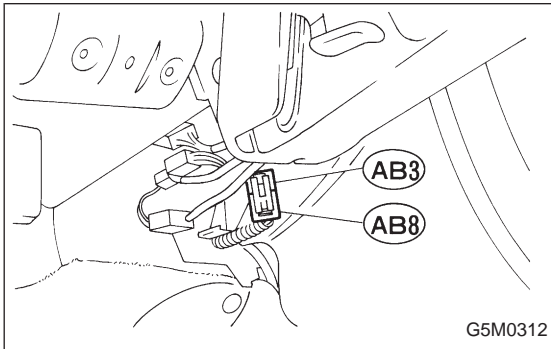

**4. AIRBAG MAIN HARNESS INSPECTION**

- 1) Turn ignition switch "OFF", disconnect battery ground cable and then wait at least 20 seconds.
- 2) Connect body harness connector (B31) and connector (AB1).
- 3) Disconnect connectors (AB3) and (AB8) below steering column. <Ref. to 5-5 [M2-6].>

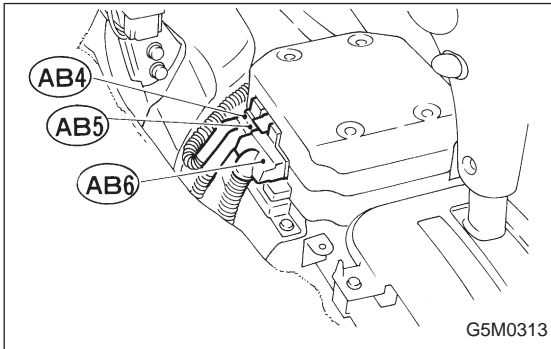

- 4) Disconnect connector (AB6) from airbag control module. <Ref. to 5-5 [W6A0].>
- 5) Connect battery ground cable and turn ignition switch "ON" to make sure airbag warning light illuminates.

**P: WARNING LIGHT INDICATES TROUBLE CODE, THEN NORMAL CODE.**

**— FLASHING TROUBLE CODE. —**

**DIAGNOSIS:**

- Airbag system component parts are faulty.

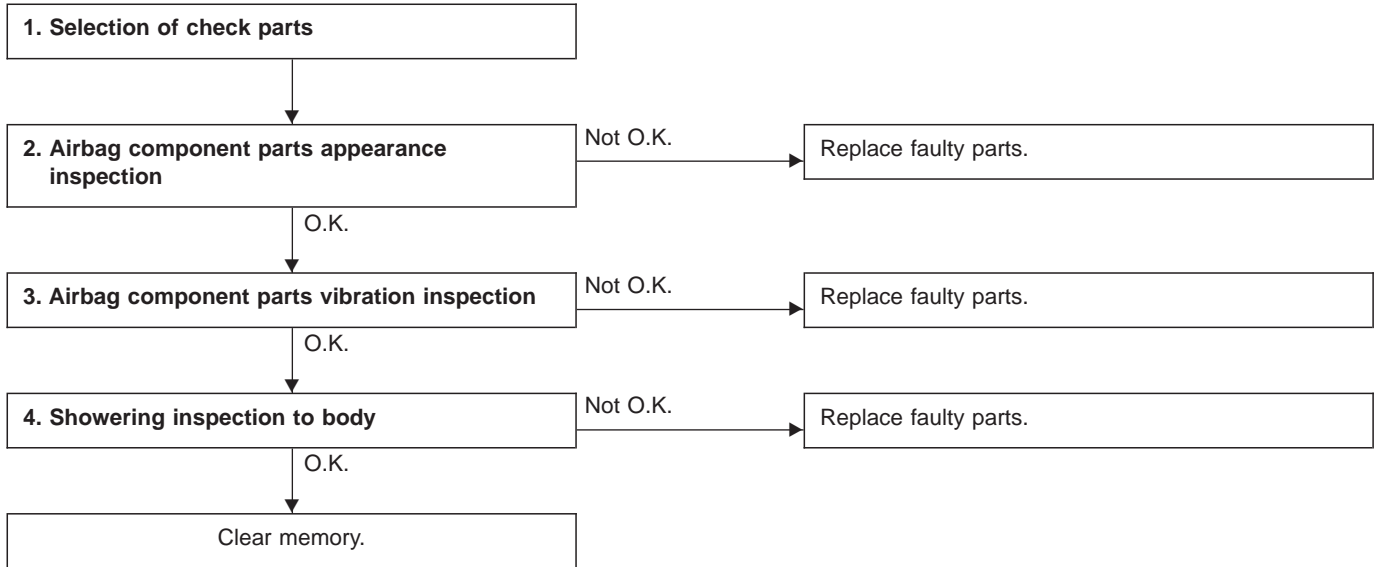

**CAUTION:**

**Before performing diagnostics on airbag system, turn ignition switch “OFF”, disconnect battery ground cable, and then wait at least 20 seconds.**

**1. SELECTION OF CHECK PARTS**

1) Conduct on-board diagnostic and call up trouble codes stored in memory. <Ref. to 5-5 [T4B0].>

2) Select trouble code required to check airbag component parts from those listed in table and reproduce symptom.

Trouble codes	Check parts	Refer to 5-5:
02	<ul style="list-style-type: none"> <li>● Front sensor (RH, LH)</li> <li>● Airbag main harness</li> <li>● Airbag module (Driver/Passenger)</li> <li>● Roll connector</li> <li>● Airbag control module</li> </ul>	W4A0 W5A0 W3A1—W3A2 W7A0 W6A0
03	<ul style="list-style-type: none"> <li>● Front sensor (RH, LH)</li> <li>● Airbag control module</li> </ul>	W4A0 W6A0
04	<ul style="list-style-type: none"> <li>● Airbag module (Passenger)</li> <li>● Airbag main harness</li> <li>● Airbag control module</li> </ul>	W3A2 W5A0 W6A0
11	<ul style="list-style-type: none"> <li>● Fuse No. 8</li> <li>● Airbag main harness</li> <li>● Airbag control module</li> <li>● Body harness</li> </ul>	T5D3 W5A0 W6A0 —
12	<ul style="list-style-type: none"> <li>● Roll connector</li> <li>● Airbag module (Driver)</li> <li>● Airbag main harness</li> <li>● Airbag control module</li> </ul>	W7A0 W3A1 W5A0 W6A0
13	<ul style="list-style-type: none"> <li>● Airbag module (Driver)</li> <li>● Roll connector</li> <li>● Airbag main harness</li> <li>● Airbag control module</li> </ul>	W3A1 W7A0 W5A0 W6A0
21	<ul style="list-style-type: none"> <li>● Airbag control module</li> </ul>	W6A0
22	<ul style="list-style-type: none"> <li>● Airbag module (Passenger)</li> <li>● Airbag main harness</li> <li>● Airbag control module</li> </ul>	W3A2 W5A0 W6A0
23	<ul style="list-style-type: none"> <li>● Airbag main harness</li> <li>● Roll connector</li> <li>● Airbag module (Driver/Passenger)</li> <li>● Front sensor (RH, LH)</li> <li>● Airbag control module</li> </ul>	W5A0 W7A0 W3A1—W3A2 W4A0 W6A0
24	<ul style="list-style-type: none"> <li>● Airbag module (Driver)</li> <li>● Roll connector</li> <li>● Airbag main harness</li> <li>● Airbag control module</li> </ul>	W3A1 W7A0 W5A0 W6A0
32	<ul style="list-style-type: none"> <li>● Airbag module (Passenger)</li> <li>● Roll connector</li> <li>● Airbag main harness</li> <li>● Airbag control module</li> </ul>	W3A2 W7A0 W5A0 W6A0

## 2. AIRBAG COMPONENT PARTS APPEARANCE INSPECTION

Conduct appearance inspection on parts selected.

### NOTE:

Also check connector terminals, wiring harness, case, etc. for damage.

## 3. AIRBAG COMPONENT PARTS VIBRATION INSPECTION

- 1) Gently shake check parts (to determine faults.).
- 2) To check airbag module or roll connector, turn and tilt steering wheel.

### CAUTION:

**Do not shake or vibrate airbag control module and front sensor at the same time as erroneous operation may result.**



## 4. SHOWERING INSPECTION TO BODY

- 1) Spray water on vehicle body.

### CAUTION:

**Do not directly spray water on airbag components.**

- 2) Check passenger compartment for traces of leaking.

### NOTE:

Also check wiring harnesses as water may leak along them and get airbag component parts wet.

**Q: WARNING LIGHT INDICATES TROUBLE CODE, THEN NORMAL CODE.  
— FLASHING NORMAL CODE. —**

**DIAGNOSIS:**

- Airbag connector is faulty.
- Fuse No. 16 is blown.
- Airbag main harness is faulty.
- Airbag control module is faulty.
- Body harness is faulty.

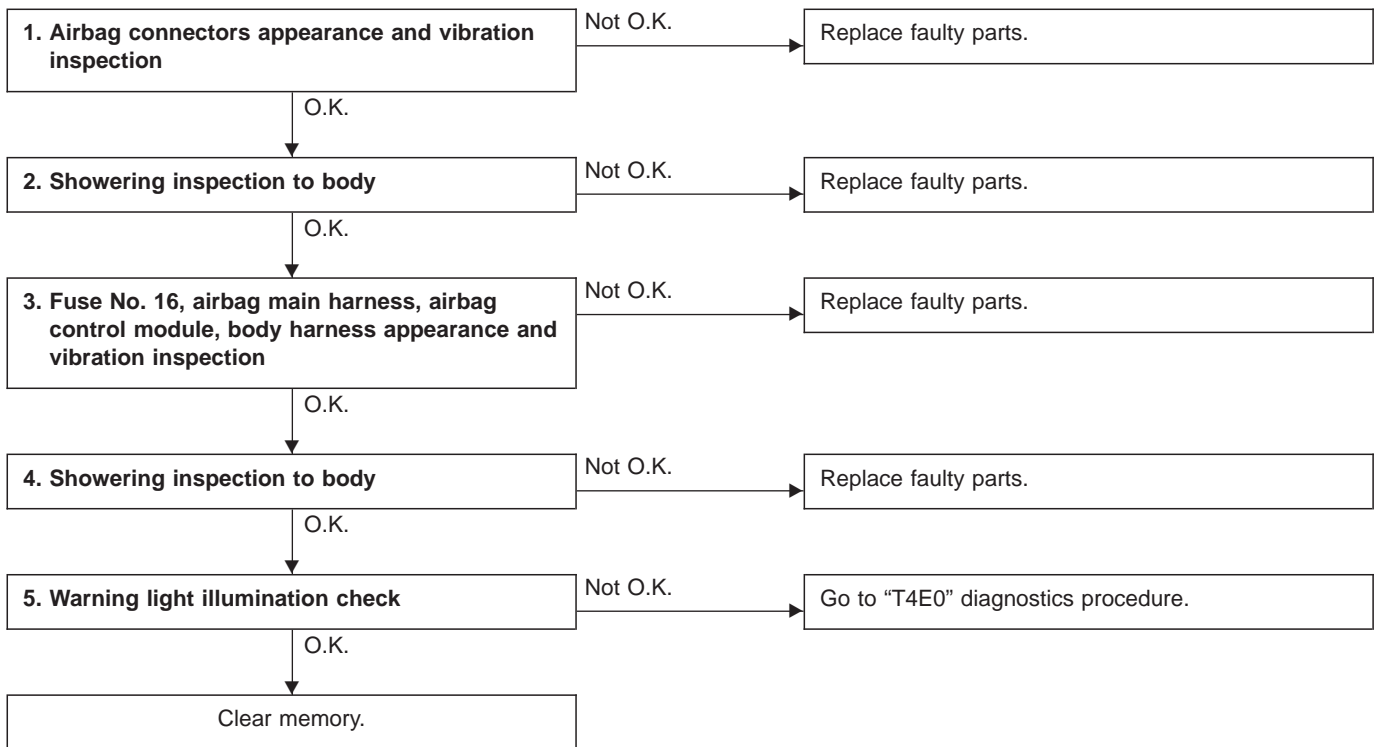

**CAUTION:**

**Before performing diagnostics on airbag system, turn ignition switch "OFF", disconnect battery ground cable, and then wait at least 20 seconds.**

**1. AIRBAG CONNECTORS APPEARANCE AND VIBRATION INSPECTION**

1) Conduct appearance inspection on airbag connectors (AB2 through AB8). <Ref. to 5-5 [T100].>

**NOTE:**

Check terminals, case and wiring harnesses for damage.

2) Conduct vibration inspection on airbag connectors (AB2 through AB8). <Ref. to 5-5 [T100].>

**NOTE:**

Gently shake each airbag connector.



## 2. SHOWERING INSPECTION TO BODY

- 1) Spray water on vehicle body.

### CAUTION:

**Do not directly spray water on airbag components.**

- 2) Check passenger compartment for traces of leaking.

### NOTE:

If leaks are noted, also check wiring harnesses as water may leak along them and wet airbag connectors.

## 3. FUSE No. 16, AIRBAG MAIN HARNESS, AIRBAG CONTROL MODULE, BODY HARNESS APPEARANCE AND VIBRATION INSPECTION

- 1) Conduct appearance inspection on fuse No. 16 <Ref. to 5-5 [T5L3].>, airbag main harness <Ref. to 5-5 [W5A0].>, airbag control module <Ref. to 5-5 [W6A0].> and body harness.

### NOTE:

Also check connectors, terminals, wiring harness and case for damage.

- 2) Conduct vibration inspection on fuse No. 16, airbag main harness, airbag control module and body harness.

### NOTE:

Gently shake each part.



## 4. SHOWERING INSPECTION TO BODY

- 1) Spray water on vehicle body.

### CAUTION:

**Do not directly spray water on each part.**

- 2) Check passenger compartment for traces of leaking.

### NOTE:

If leaks are noted, check wiring harnesses as water may leak along them and get parts wet.

## 5. WARNING LIGHT ILLUMINATION CHECK

Turn ignition switch "ON" (engine off) and observe airbag warning light.

Airbag warning light comes "ON" for 8 seconds then goes out and stays out.