

3. Airbag Module

A: REMOVAL AND INSTALLATION

CAUTION:

- The airbag module (driver, passenger and side) must not be disassembled. The airbag module cannot be used again once inflated.

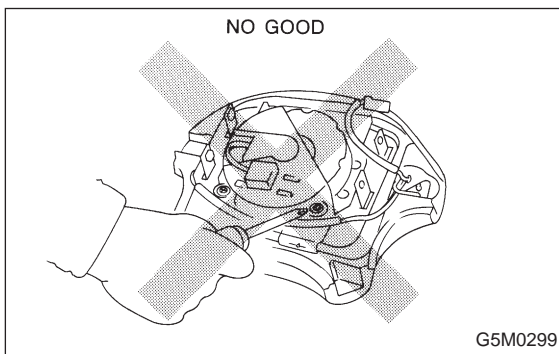

- When removing and installing the airbag module (driver, passenger and side), the operator should stand, as much as possible, on the side of the airbag module.

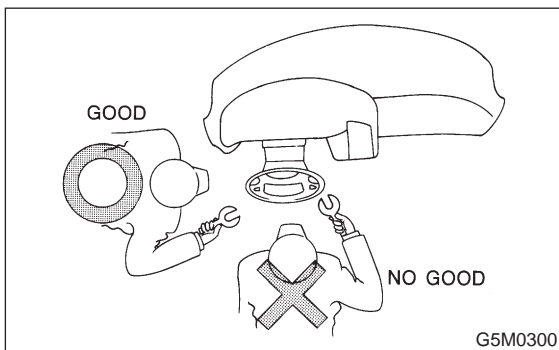

- After removal, the airbag module (driver, passenger and side) should be kept away from heat and light sources, and stored on a clean, flat surface to prevent from any damage to its lower structure.

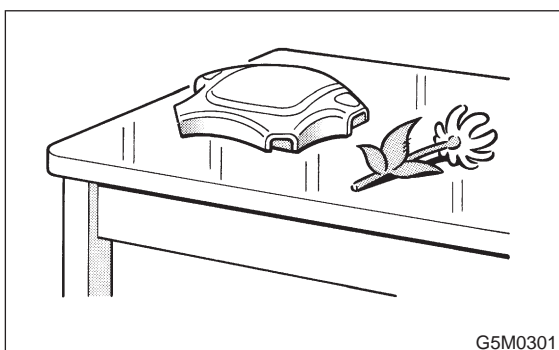

- Do not check airbag module (driver, passenger and side) continuity with airbag removed from the vehicle body.

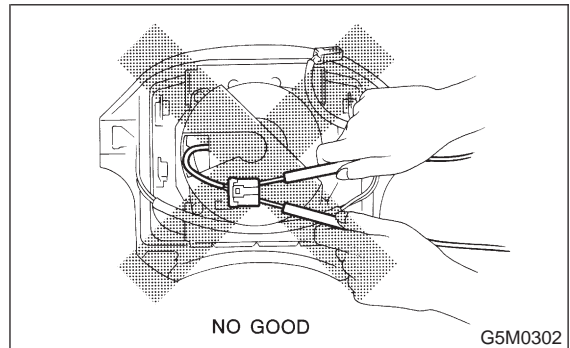

- Replace airbag module (driver, passenger and side) with a new one, should any of the following conditions develop:
 - Pad surface is scratched or cracked.
 - Connector harness is damaged.
 - Inflator side structure of module is cracked or deformed.
 - Module is excessively stained with water, oil, etc.
 - Module was accidentally dropped.
 - The front seat assembly is damaged or deformed.
- The removed front seat with the airbag module must be kept on its back. At this time, keep the module side at least 200 mm (7.87 in) away from walls or other objects.

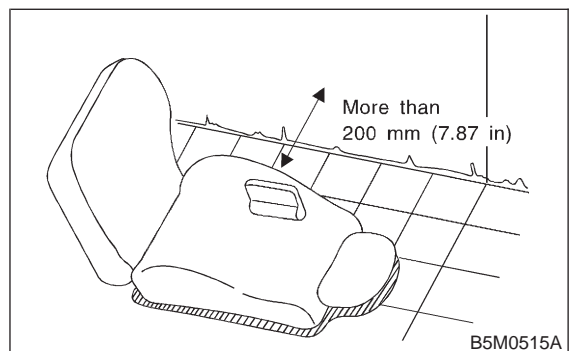

- When storing a removed airbag module (driver and passenger), be sure to place it in parallel with floor with the pad facing up. Do not place it against a wall, or place anything on the pad; otherwise, a dangerous condition may be created if the module malfunctions.

Driver side

GOOD

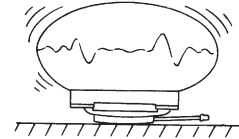
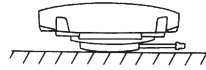

NO GOOD

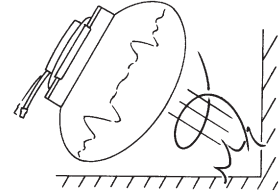
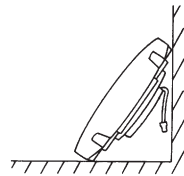

NO GOOD

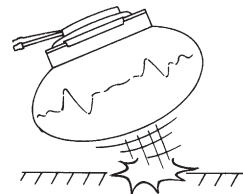
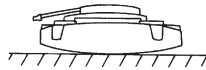

NO GOOD

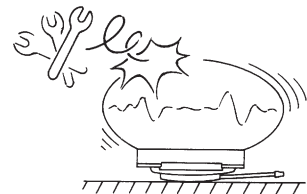
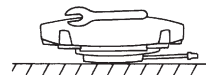

Passenger side

GOOD

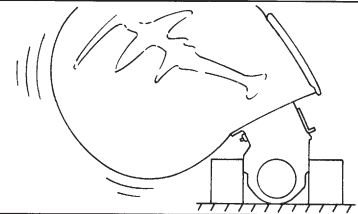
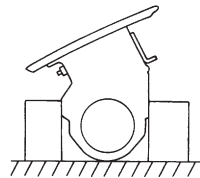

NO GOOD

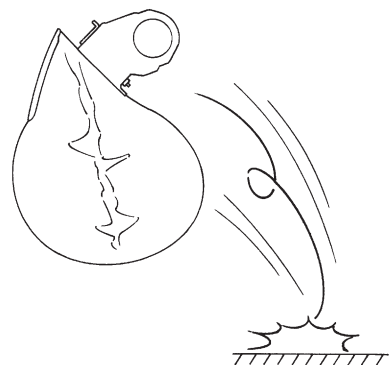
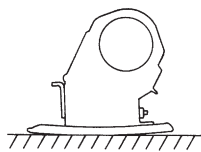

NO GOOD

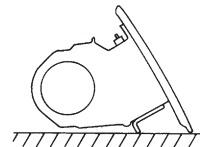

G5M0604

1. DRIVER'S AIRBAG MODULE

- 1) Set front wheels in straight ahead position.
- 2) Turn ignition switch off.
- 3) Disconnect ground cable from battery and wait for at least 20 seconds before starting work.

- 4) Using TORX® BIT T30, remove two TORX® bolts.

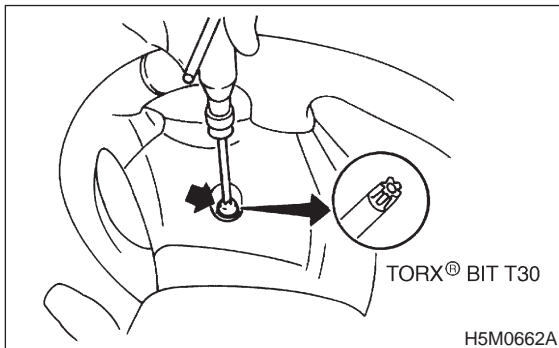

CAUTION:

Do not allow harness and connectors to interfere or get caught with other parts.

3. SIDE AIRBAG MODULE

The side airbag module cannot be detached from the front seat assembly. When replacing side airbag module, replace front seat assembly. <Ref. to 5-3 [W1A0].>

- 5) Disconnect airbag connector on back of airbag module. <Ref. to 5-5 [M2F2].>

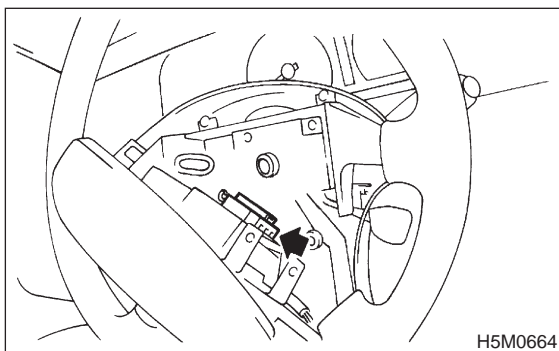

- 6) Refer to “**CAUTION**” for handling of a removed airbag module. <Ref. to 5-5 [W3A0].>

- 7) Installation is in the reverse order of removal.

CAUTION:

Do not allow harness and connectors to interfere or get caught with other parts.

2. PASSENGER’S AIRBAG MODULE

- 1) Remove instrument panel. <Ref. to 5-4 [W1A0].>

- 2) Remove four bolts and then carefully remove airbag module.

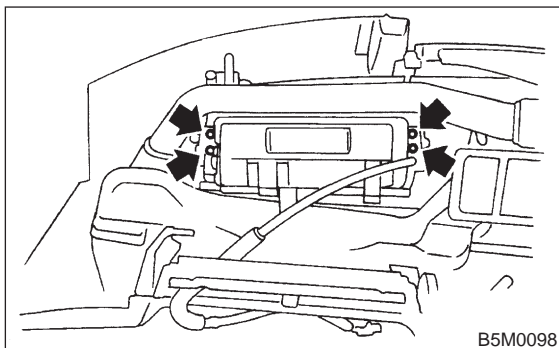

- 3) Refer to “**CAUTION**” for handling of a removed airbag module. <Ref. to 5-5 [W3A0].>

- 4) Installation is in the reverse order of removal.