

2. Schematic

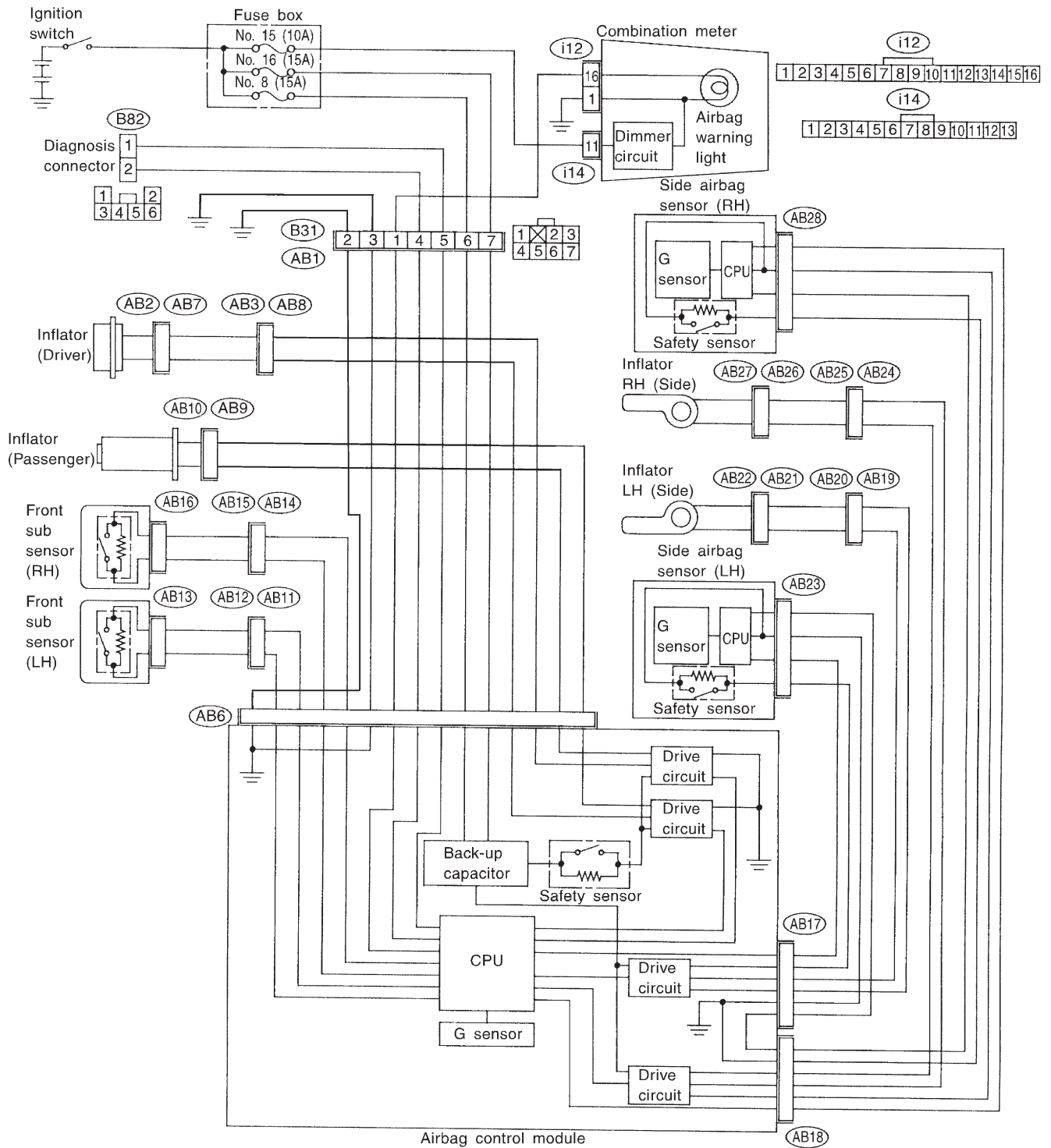

B5M0522A