

4. Schematic

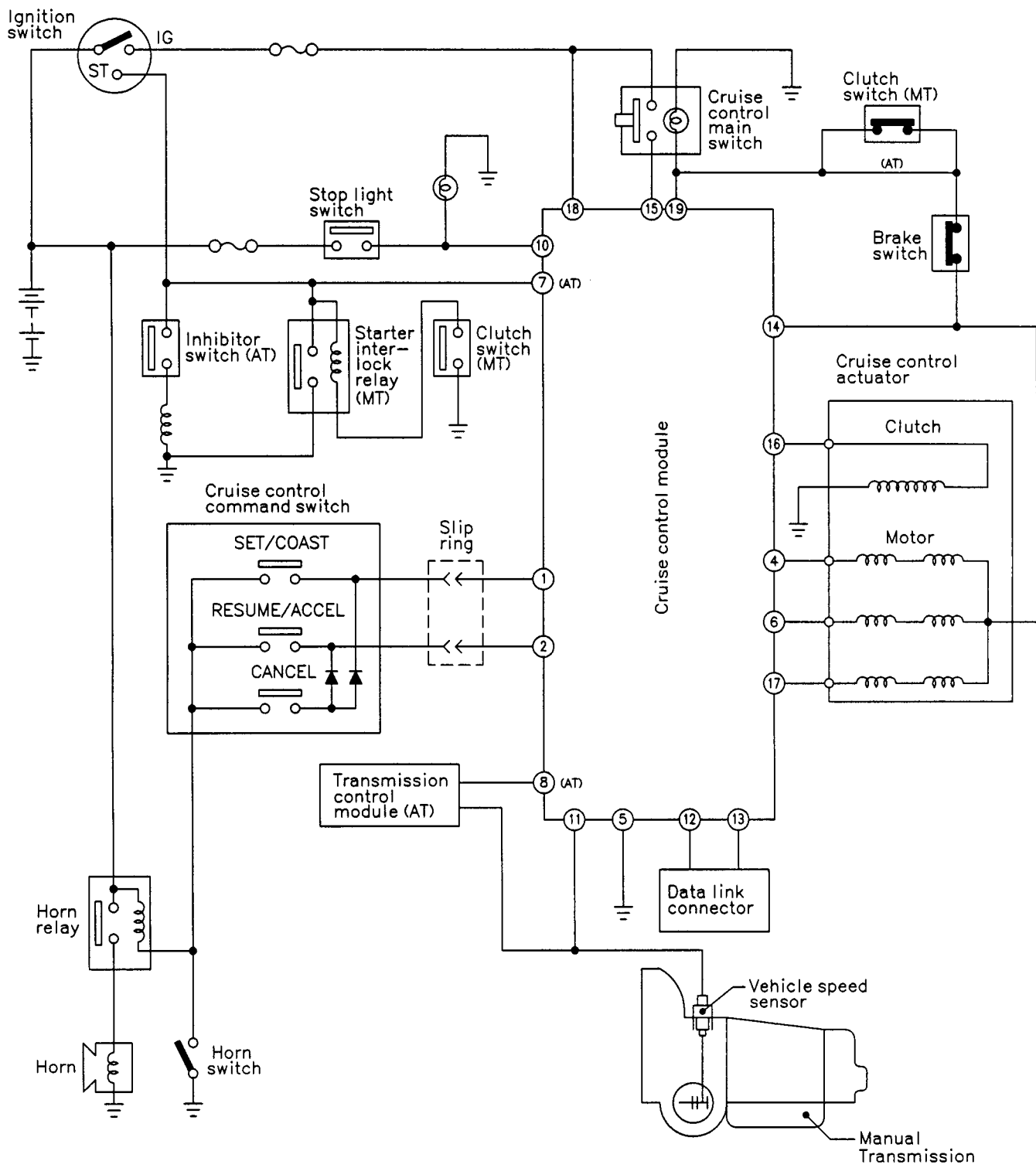

B6M1399